

BPR-2L-VM-SWG

TEST BENCH FOR MECHANICAL ENDURANCE TESTS WITH TWO STATIONS - 2024

INDEX

1 - INTRODUCTION	2
2 - CONFIGURATION	4
2.1 - BPR-2L-VM-SWG	4
2.1.1 - Operative range:	4
2.1.2 - Basic software installed:	4
2.1.3 - Ethernet connection:	4
2.1.4 - Service functionalities:	5
2.1.5 - AQ2TB-MANSYS	6
2.1.6 - Main components:	7
2.1.7 - PC and software:	7
2.1.8 - Structural characteristic of the bench:	8
2.1.9 - Transducers installed:	9
2.1.10 - Technical data:	10
3 - EQUIPMENT FOR ENDURANCE TESTS	11
3.1 - MECHANICAL ENDURANCE OF SINGLE LEVER MIXERS	12
4 - ADDITIONAL EQUIPMENTS AND APPLICATIONS	14
4.1 - MECHANICAL ENDURANCE OF SWIVEL SPOUTS	14
4.2 - MECHANICAL ENDURANCE OF ON/OFF CONTROL DEVICES	15
4.3 - MECHANICAL ENDURANCE OF PROGRESSIVE CARTRIDGES	16
4.4 - MECHANICAL ENDURANCE OF DIVERTER CARTRIDGES.....	17
4.5 - MECHANICAL ENDURANCE OF DIVERTERS.....	18
4.6 - MECHANICAL ENDURANCE OF TEMPERATURE CONTROL DEVICE.....	19
4.7 - MECHANICAL ENDURANCE OF MULTI-WAY SELECTORS	20
5 - OPTIONAL EQUIPMENTS, APPLICATIONS AND ACCESSORIES	21
5.1 - AQ2TB-COMBI-PR	21
5.2 - AQ2TB-COMBI-LAB+	21
5.3 - AQ2TB-COMBI-LM.....	22
5.4 - AQ2TB-COMBI-RM.....	22
5.5 - AQ2TB-ASV	22
5.6 - SENSITIVITY AND FIDELITY TEST	24
5.7 - BPR-OPZ-SL-FM	25
5.8 - THERMAL SHOCK TEST	27
5.9 - PRESSURE RESISTANCE AT ELEVATED TEMPERATURE	28
5.10 - MECHANICAL STRENGTH CHARACTERISTICS	29
5.11 - AQ2TB-ASTD	30
5.12 - BPR-OPZ-ES01	31
5.13 - KIT OF SUPPORTS.....	31
5.14 - KIT OF ACCESIORES FOR ROTARY MOTOR.....	32
5.15 - SPARE PARTS KIT.....	33
6 - WATER SUPPLY	34
6.1 - TCW B2.....	34
6.2 - BPR-OPZ-HCR.....	34
7 - PACKAGING	35
7.1 - BPR-2L-VM-SWG PACKAGING.....	35
7.2 - TCW B2 PACKAGING	35
7.3 - ACCESSORIES PACKAGING.....	35
8 - EXAMPLE	36

Both stations are able to perform life cycles controlling through the software direction, force, torque and duration; temperature, pressure and flow rate are monitored continuously.

The results are recorded and it is possible to generate anytime a report for each tests.

On both stations, it is possible to connect the devices in a position that avoid the generation of eccentric forces during the tests.

In addition, it is possible, at the end of the endurance test, or anytime according to the test parameters, to submit the device under test to a static pressure check without removing the component from the test station.

The test bench is equipped with two independent workstations with 23" LCD 16:9 monitors and acquisition cards in order to allow the real-time analysis and recording of all test parameters; each test can be displayed or saved with the most significant diagrams. The standard software package includes a service software with calibration, messages, alarms, change of language and users management functionalities.

DURING THE CYCLE

It is possible to read in real time all the parameters: flow-rate, temperature, pressure, position, force torque, number of cycles etc... and see on the graph the variation of the most relevant parameters.

TEST REPORT

The test report includes:

All the information regarding the component under test.

The starting conditions.

The test executions (limits, time, tolerance etc...).

The total number of cycle with the list of the errors and fail cycles.

The information regarding the start and end time, the total working time, including interruptions and recoveries.

During the test is possible to print or save some specific cycle according the request.

FINAL REPORT

At the end of each cycle, the system saves the maximum and minimum values of resistant torque and force in order to present, at the end of the endurance test, the graph with the variation of these parameters during the test. This information is very important for R&D technicians to analyze the behavior of the components and to prevent future damages.

2 - CONFIGURATION

2.1 - BPR-2L-VM-SWG

2.1.1 - Operative range:

Flow-rate and temperatures depend on the external supply system.

- Operating temperature hot water:	40 ÷ 90 °C
- Operating temperature cold water:	10 ÷ 25 °C
- Dynamic pressure:	0,1 ÷ 10 bar
- Maximum static pressure:	48 bar
- Total mixed water flow-rate:	1 ÷ 20 L/min
- Adjustable angular speed:	0,5 ÷ 300 °/s
- Adjustable torque:	1 ÷ 10 Nm
- Adjustable linear speed:	1 ÷ 300 mm/s
- Adjustable linear force:	1 ÷ 44 N

2.1.2 - Basic software installed:

- A) **AQ2TB-BASEMOD** “SWG” service software with multichannel acquisition engine, management of users, calibration, change of language, messages, water and air temperature regulation (if available on the bench).
- B) **WINDOWS 10** OEM Multilanguage.
- C) **MACRIUM BACKUP** automatic back up of test data and operative system.
- D) **SOMACHINE** software for management of PLC.
- E) **TEAM VIEWER** internet remote control.

Basic software included is in Italian language + second language English or German. Others languages only by request with extra cost.

2.1.3 - Ethernet connection:

The test bench is provided with Ethernet plug in order to allow the connection to Internet and enable the remote assistance functionalities through TEAMVIEWER software (installed by default on the PC).

The Ethernet plug also allows the integration of the bench inside the customer’s network (intranet). In this way is possible to export data and reports and remotely check the functioning of the bench. It allows, in conjunction with AQ2TB-MANSYS software, the incoming (from corporate server to test bench) and outgoing data exchange (from bench to server).

2.1.4 - Service functionalities:

- AQ2TB-OPZ-MLG** Possibility to generate and print in five different languages (Italian, English, German, French and Spanish) all the test reports. The language of the report is independent from the language of the software. Each report can be generated more than one time in different languages.
- AQ2TB-DATA-EXP** Possibility to export in a TXT format file all the samples acquired during a test. It is possible to activate this function for all the software; this function is independent by the graphs shown in each software. For laboratory tests, it is possible to export the data of the entire test. For endurance tests, it is possible to export data of a single cycle, the number of saved cycle can be chosen by the operator. The maximum acquisition frequency is about 10 Hz (sample per second) for each channel.
- AQ2TB-TCW-ETH** Option to manage the functioning of the TCW generator by Ethernet communication from the test bench.
Includes the possibility to choose the working modality (on/off – stand-by – weekly switch-on timer), read in real time the temperature of hot and cold water, modify the set points, and manage the alarms (real time status reading and events history).
- AQ2TB-DATA-INFO** Additional option for the personalization of the test information in all the active languages. The standard menu, composed in English by the entries “*Client*”, “*Category*”, “*Line*”, “*Model*”, “*Serial number*” and “*Test description*” can be modified in order to adapt the management of the tests on bench (including the reports) to the modality adopted by the company internally.

2.1.5 - AQ2TB-MANSYS

This optional software, installable on one or more PCs with suitable characteristics and integrated into the company network, can be used for remote management activities on the test bench.

Software specification:

- The software allows the remote creation, modification and cancellation of the tests execution parameters for each test. (*)
- The software allows the access to the test data and, consequently, to their analysis and exportation; it allows the creation of the test report independently from the activity carried out on the bench in that moment. (**)
- It allows the visualisation of the bench status (normal functioning or in alarm) and the kind of test in execution in real time. (**)
- It allows the creation of test information registry usable on the bench during the saving procedure. (*)

* The bench will not have access to data in case of absence of network connection.

** Features active only in case of available network connection.

Notes:

- In case of absence of network connection, the normal functioning of the bench is always guarantee.
- The effective functioning of the software depends on the corporate server features, and cannot be guaranteed before the start-up of the bench.

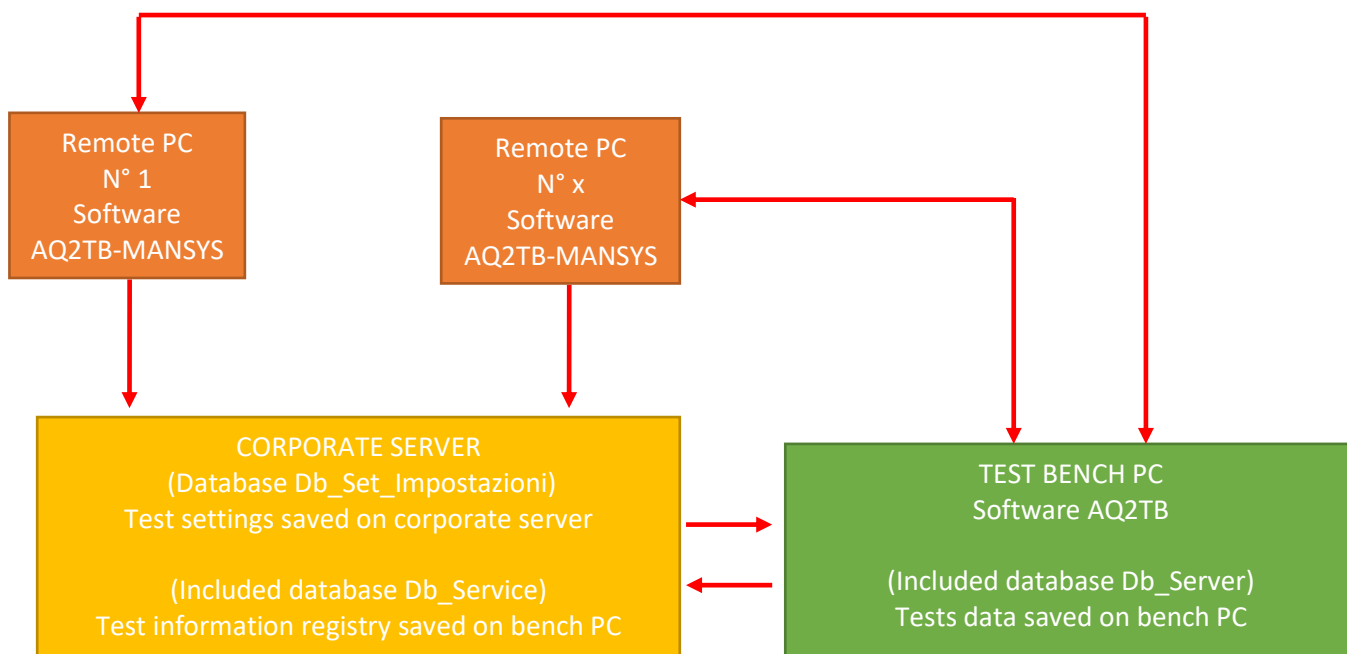

2.1.6 - Main components:

- **Two testing station to connect the faucet under test, two outlets ¾”** with 150 mm axial pitch, size and dimensions according EN 1111 standard and dedicate support to mount many type of taps.
- **Two multi-stage vertical pumps** with speed control, inverter and feedback pressure transducers. Pressure adjustable from 0,1 up to 10 bar, with 47 L/min maximum flow-rate, the pressure is kept constant independently of the supply flow-rate.
- **Test area approx. 1500 x 500 x (h) 1100 mm with two test stations:**
Each testing area is equipped with aluminium square profiles and supports. It is possible to connect the components under test by flexible hoses for supply with hot and cold water.
A safety door for protection with a door lock switch enabled only during the life tests.
The test basin in stainless steel is equipped with drain and supports in aluminium with tracks for the eventual fixing of tested elements.
- **Two hand pumps** integrated in the hydraulic plant for static pressure test up to 48 bar.
- **Two rotary motors** directly controlled by PLC and PC, maximum torque 10 Nm, Ethernet communication. The devices allow an interactive control of rotation, angular speed and torque. Feedback control of maximum torque.
- **Two linear motors** directly controlled by PLC and PC, maximum force 67 N, Ethernet communication. The devices allow an interactive control of position, speed and force. Feedback control of maximum force.
- The motors are fixed on a support in aluminium with the possibility to adjust the height.

2.1.7 - PC and software:

Installed WORKSTATION consisting of:

- **Intel processor** – the configuration changes according the last components in the market: acquisition card National Instruments, network cards, two hard disks, DVD burner.
- **Keyboard and mouse wireless.**
- **A4 colour laser printer and support trolley – Code: KIT-LASERPRINTER.**
- **23” LCD monitor 16:9**, assembled on adjustable holder.
 - Available on request **Touchscreen monitor - Code: 4MONITOR23-TS.**
- **UPS power supply 500 W.**
- **Back-up external unit – USB HDD.**
- **Instruction manuals and Help on-line.**

Operative system and acquisition software SWG:

- Operative system: **Windows 10 Enterprise LTSC.**
- **Dedicated software: SWG 2024** to perform endurance tests.
The new multilanguage software SWG allows to work with different units of measure, it allows to acquire the parameters for the functioning of the bench and to provide documentation for the tests through the following screens:
 - ◇ Start-up screen with several options available: the account (admin/users) and passwords management, calibration, transducers check, selection of software language, units of measure, messages and software for the execution of the tests.
 - ◇ Main screen showing the virtual synoptically panel, with all the measures acquired in real time.
 - ◇ Specific screen showing force and torque in a graphic format with adjustable video size, possibility to perform enlargements of the working area. All the supply conditions (temperature, pressure and flow-rate) are shown and controlled continuously. Final report

with the starting conditions, the maximum values of force and torque and the summary of failed cycles. It is always possible to save a single cycle report containing a significant video screen and the maximum values of force and torque for that cycle.

- ◇ Final report with all the test data and a significant video screen. It is possible to generate each report in different languages.
- ◇ It is possible to control the opening and closing of all the internal valves and the pumps by clicking with the mouse on the graphic symbol representing each components in the synoptic panel.
- ◇ All the existing screens may be printed with customer's notes and logo.
- ◇ Help On-line support, with all the main operational instructions.

2.1.8 - Structural characteristic of the bench:

- Supporting structural frame made of aluminium and laminated panels.
- Slide guide for holder, anticorrosive made for fixing the samples under test.
- Assembly on rotating wheels provided with parking brakes.
- Working tank in stainless steel (1,5 mm) with drain.
- Internal hydraulic plant for the supply of hot and cold water, made with thermally insulated stainless steel piping, adequate to supply at the maximum nominal flow-rate.
- Valves installed on hydraulic plant with pneumatic actuators.
- Double-stage filter unit.
- Internal separation between hydraulic plant and the area with PC and electrical cabling.
- Testing area with protection door.

2.1.9 - Transducers installed:

TEMPERATURE:	accuracy $\pm 0,3$ °C, resolution 0,01 °C. Pt100 low-inertia, 3-wires probes. thermocouple K fast response.
PRESSURE:	operative range 0-50 bar. accuracy $\pm 0,10\%$ of the full-scale value. resolution 0,01 bar, pressure probes with high dynamic response.
FLOW-RATE:	accuracy $\pm 0,25\%$ of reading value (from 5 to 47 L/min). resolution 0,01 L/min with precision electromagnetic flow meter with output connected to microprocessor converter.
FORCE:	operative range 0-250 N. accuracy $\pm 0,5$ N, resolution 0,01 N.
TORQUE:	operative range 0-10 Nm. accuracy $\pm 0,1$ Nm, resolution 0,01 Nm.

The measuring equipment assembled on the bench is equipped with an inspection report relative to the operational fields and performed according to the ISO 9001 standards, with reference to the ACCREDIA (Italian Calibration Service) primary samples.

The test bench is provided with a final test report of electrical safety according to standard CEI EN 60204-1 and CE declaration of conformity.

2.1.10 - Technical data:

WEIGHT AND DIMENSION	
- LENGTH	3000 mm
- DEPTH	1100 mm (+100 mm)
- HEIGHT	1800 mm (+100 mm)
- WEIGHT (APPROX.)	700 kg
SUPPLY CHARACTERISTICS	
- ELECTRICAL SUPPLY	400 V 3 phases + N + GND 50 Hz
- POWER	9,0 kW
- HYDRAULIC SUPPLY (From external tanks or TCW B2)	10+10 L/min
- PNEUMATIC SUPPLY	6÷9 bar
- WATER DRAIN FLOW	80 L/min
- WATER TEMPERATURE (From external tanks or TCW B2)	10÷90 °C

3 - EQUIPMENT FOR ENDURANCE TESTS

Endurance equipment:

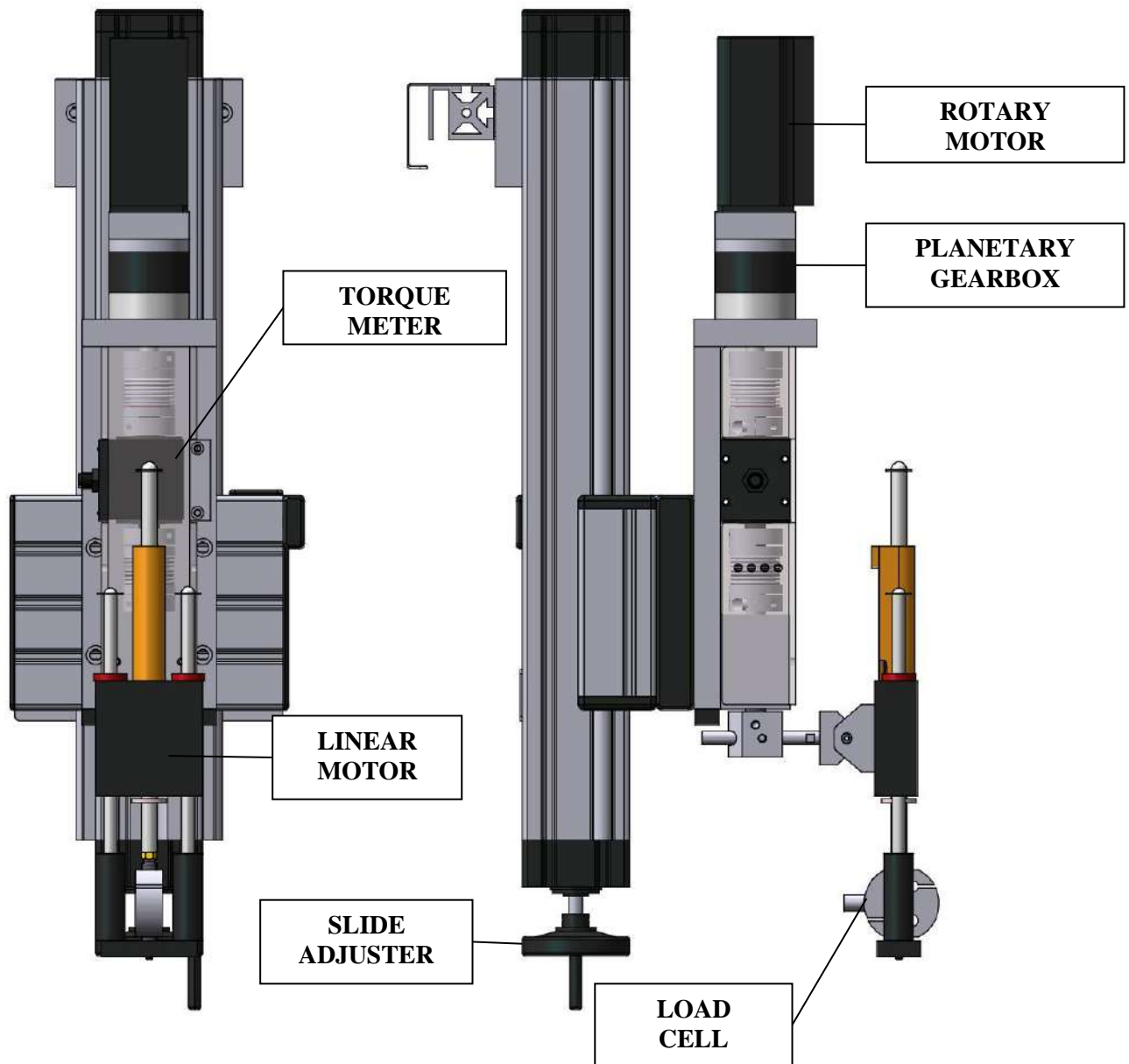

3.1 - Mechanical endurance of single lever mixers

Description:

The movement system is used in order to verify the mechanical resistance of the maneuvering device of mechanical mixers.

The procedure consists in subjecting the handle device to a given number of movements at specified pressure and water temperatures. It is possible to perform the test supplying the taps with hot and cold water at the same time (EN standard), alternately with hot and cold water (CSA standard), or with the same water for the entire test.

Installed software:

AQ2TB-LM-ENCSA test code : ESL01

Life test software according to standards EN 817, EN 1286, ASME A112.18.1/CSA B125-1 and NF 077 TD077-03.

The installed software allows to control:

Rotating movement – angle of rotation, angular speed and torque.

Linear movement – position, linear speed and force.

Note: special software are available at request to perform endurance tests on joystick cartridges or other components:

- **Joystick cartridge: AQ2TB-LM-JOST**

Description of the test cycle:

The test consists in subjecting the manoeuvre device, to the indicated pressures and temperatures of hot and cold water, to a specific number of time-set movements.

Example of rectangular cycle according to the standard EN 817 (chap. 12.1)

- Mount the single lever mixer to be tested and connect to the hot and cold water supply circuits.
- Regulate the maximum force transmitted from the machine in order to open and close the flow control device and move the temperature adjustment device with a 3 Nm torque.
- With the mixer closed, regulate the hot and cold-water static pressures.
- Subject the mixer to 70.000 cycles of opening, closing and temperature regulation; for rectangular movement:
 - Start in mean mixed closed position.
 - Open and close in mean mixed position.
 - Move to cold position.
 - Open in cold-water position.
 - Move to full open hot water position and dwell for 5 s.
 - Move to cold-water position and well for 5 s.
 - Close in cold-water position.
 - Move to close hot water position
 - Open then close in hot water position.
 - Return to mean mixed closed position.

Testing conditions:

- | | |
|---|------------|
| 1. Temperature of hot water: | 65±2 °C |
| 2. Temperature of cold water: | ≤ 30 °C |
| 3. Flow rate adjustable by downstream resistance: | 6±1 L/min |
| 4. Pressure: | 4±0,5 bar |
| 5. Speed: | 60±0,5 %/s |
| 6. Number of cycles: | 70.000 |

Single lever movement device:

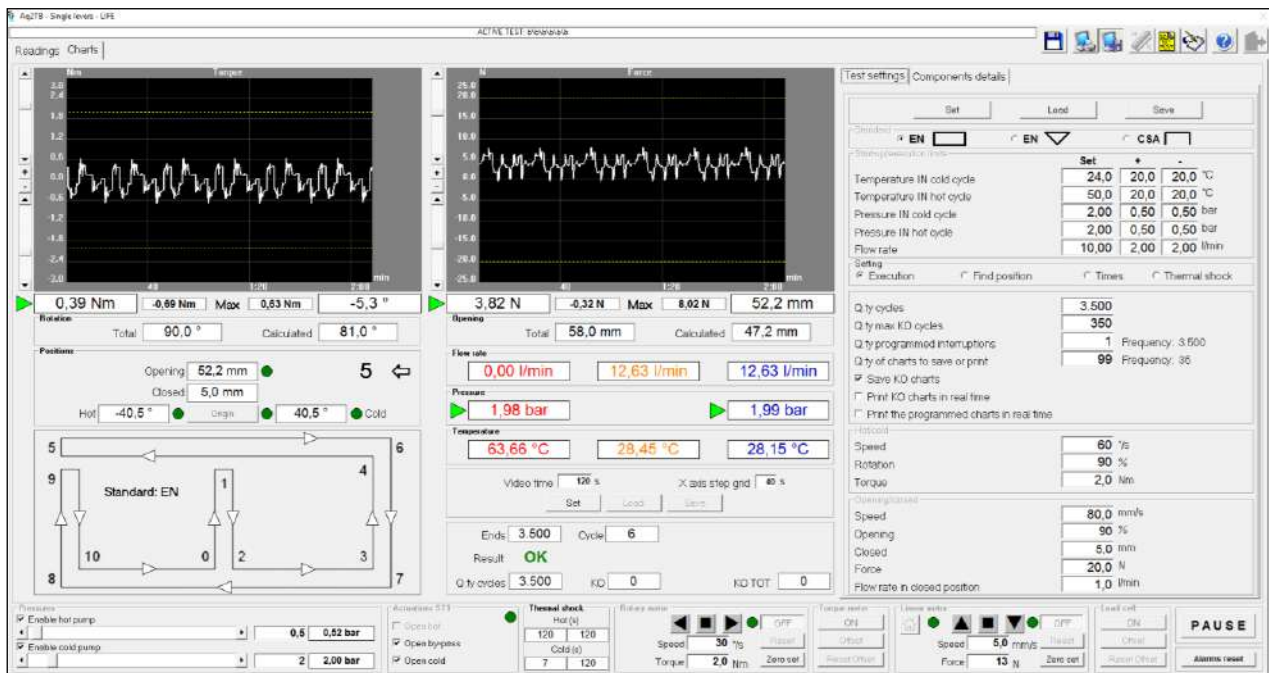
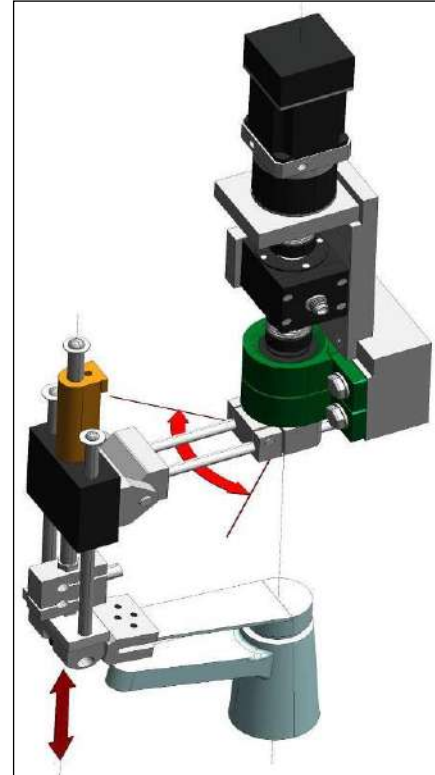

4 - ADDITIONAL EQUIPMENTS AND APPLICATIONS

4.1 - Mechanical endurance of swivel spouts

Code: BPR-OPZ-LBM

Description:

- The movement device is used in order to verify the mechanical resistance of swivel spouts. It includes the rotary motor used for endurance tests of single lever mixers.
- A calibrated weight is fixed at the end of the swivel spouts and a hydraulic resistance limits the flow-rate as indicate in the standards.
- The test cycle consists by subjecting the swivel spouts to a specific number of movements according to the standards, suppling the faucet under test alternately with cold and hot water (CSA standard), only with cold water (EN standard), only with hot water or with hot and cold water at the same time.
- The software allows to control: the rotation angle, the angular speed and torque.

Installed software:

AQ2TB-LBM-ENCSA

test code: ESS01

Life test software according to standards EN 817, EN 1286, EN 200, EN 1287 and ASME A112.18.1/CSA B125-1.

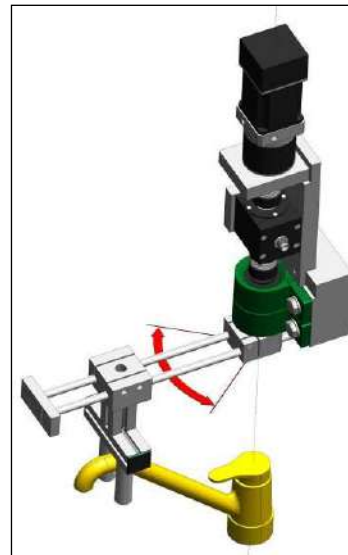

4.2 - Mechanical endurance of on/off control devices

Code: BPR-OPZ-LR

Description:

- The movement device is used in order to verify the mechanical endurance of the on/off flow control devices (traditional and ceramic single taps, valves, thermostatic mixers). It includes the torque motor used for endurance tests of single lever mixers.
- A telescopic universal joint connects the flow control under test to the torque motor.
- A calibrated hydraulic resistance mounted on the tap limits the flow-rate value as indicated in the standards.
- The test method consists in subjecting the component to a specific number of opening and closing manoeuvre; angular speed and closure torque are defined by the standards. The faucet can be supplied by hot and cold water alternately or with the same water for the entire test.
- The software allows to control: the rotation angle, the angular speed, the torque and the flow-rate.

Installable software:

AQ2TB-LR-ENCSA

test code: EFC01

Life test software according to standards EN 200, EN 1287 and ASME A112.18.1/CSA B125-1.

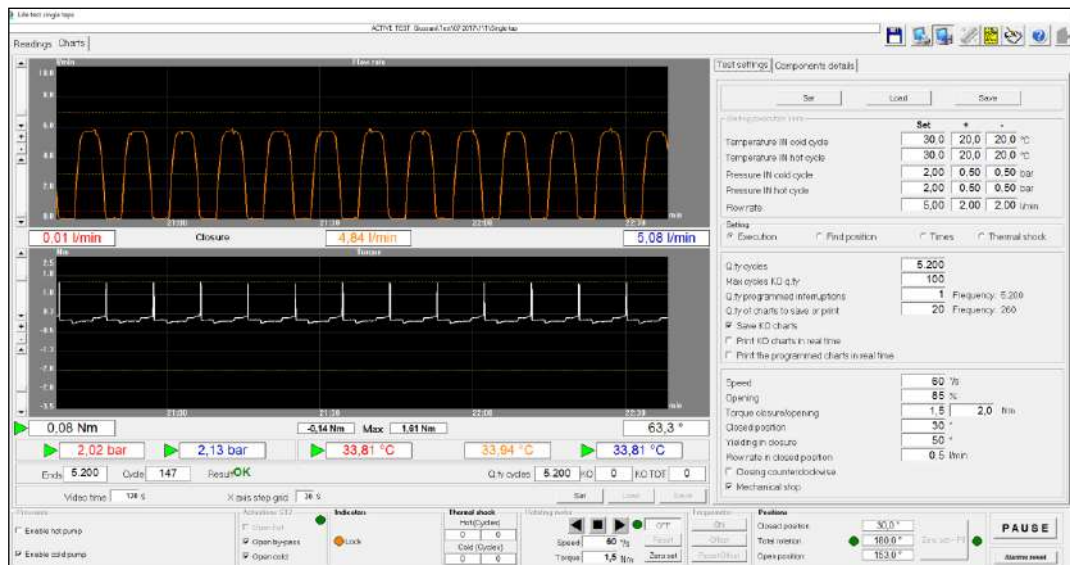

4.3 - Mechanical endurance of progressive cartridges

Code: BPR-OPZ-LPC

Description:

- The movement device is used in order to verify the mechanical endurance of progressive cartridges (from closed position, the cartridge opens at first only cold water, gradually opens also hot water until full hot position). It includes the torque motor used for endurance tests of single lever mixers.
- A telescopic universal joint connects the flow control under test to the torque motor.
- A calibrated hydraulic resistance mounted on the tap limits the flow-rate value as indicated in the standards.
- The test method consists in subjecting the component to a specific number of opening and closing manoeuvre; angular speed and closure torque are defined by the standards. The faucet is supplied by hot and cold water.
- The software allows to control: the rotation angle, the angular speed and torque and the outlet temperature in hot position.

Installable software:

AQ2TB-LPC-ENCSA

(Ref.: EN 111(2017) chap. 16.2)



4.4 - Mechanical endurance of diverter cartridges

Code: BPR-OPZ-LCD

Description:

- The movement device is used in order to verify the mechanical endurance of diverter cartridges (cartridges with two separate outlets and one closed position in the centre). It includes the torque motor used for endurance tests of single lever mixers.
- A telescopic universal joint connects the flow control under test to the torque motor.
- A calibrated hydraulic resistance mounted on the tap limits the flow-rate value as indicated in the standards.
- The test method consists in subjecting the component to a specific number of cycles between the two open positions and the central closed position; angular speed is defined by the standards. The faucet can be supplied by hot and cold water alternately or with the same water for the entire test.
- The software allows to control: the rotation angle, the angular speed, the torque and the flow-rate.

Installable software:

AQ2TB-LCD-ENCSA

(Ref.: EN 111(2017) chap. 16.4)



4.5 - Mechanical endurance of diverters

Code: BPR-OPZ-LD

Description:

- The movement device is used in order to verify the mechanical endurance of any kind of linear diverters, with or without automatic return (example: bath to shower diverters or kitchen diverters). It includes the linear motor used for endurance tests of single lever mixers.
- A calibrated hydraulic resistance mounted on the tap limits the flow-rate value as indicated in the standards.
- The test method consists in subjecting the component to cycles of repeated switch from one outlet to the other (including the pressure drop for the return of automatic diverters). The faucet can be supplied by hot and cold water alternately or with the same water for the entire test.
- The software allows to control: the stroke of the device, the linear speed, the force and the flow-rate.

Installed software:

AQ2TB-LD-ENCSA

test code : ED01

Life test software according to standards EN 817, EN 1286, EN 200, EN 1287 and ASME A112.18.1/CSA B125-1.

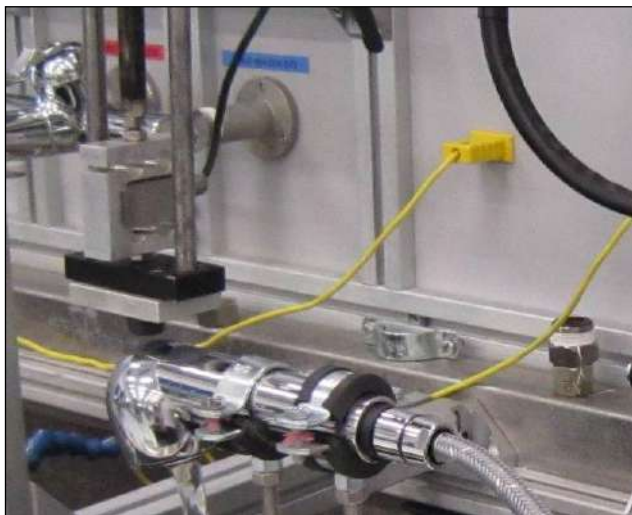

4.6 - Mechanical endurance of temperature control device

Code: BPR-OPZ-LCT

Description:

- The movement device is used in order to verify the mechanical endurance of temperature control of thermostatic mixers. It includes the torque motor used for endurance tests of single lever mixers.
- A telescopic universal joint connects the temperature control under test to the torque motor.
- The test method consists in subjecting the component to a specific number of rotations from cold to hot position and return.
- The software allows to control: the rotation angle, the angular speed, torque and the correct outlet temperature in cold and hot position.

Installed software:

AQ2TB-1LM-DRIVE

Test code: ETM02

Life test software according to standards EN 1111 (2017) and NF 077 TD077-04.

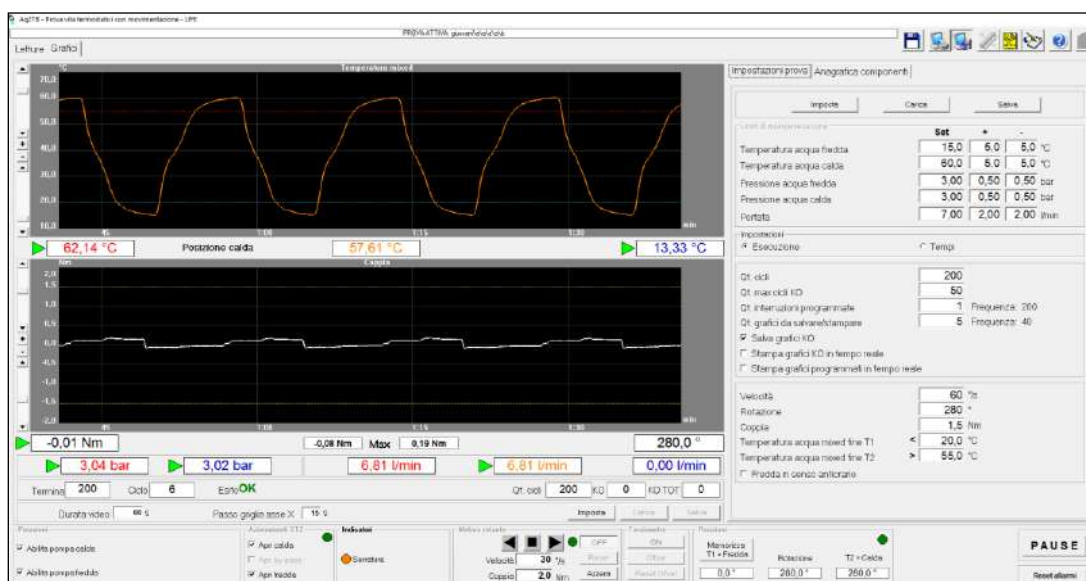

4.7 - Mechanical endurance of multi-way selectors

Code: BPR-OPZ-LMWS

Description:

- The movement device is used in order to verify the mechanical resistance of multi-ways selectors (rotating diverters, shower mechanisms, ect...). It includes the torque motor used for endurance tests of single lever mixers.
- A regulation valve limits the flow-rate as indicate in the standards.
- The test cycle consists by subjecting the selector to a specific number of movements according to the standards. The device assures an alternated movement suppling the faucet under test alternately with cold and hot water (CSA standard) or with the same water for the entire test.
- The software allows to control: the rotation angle, the angular speed, and torque.

Installed software:

AQ2TB-LMWENCSA

test code: EMWS01

Life test software according to standards ASME A112.18.1/CSA B125-1.

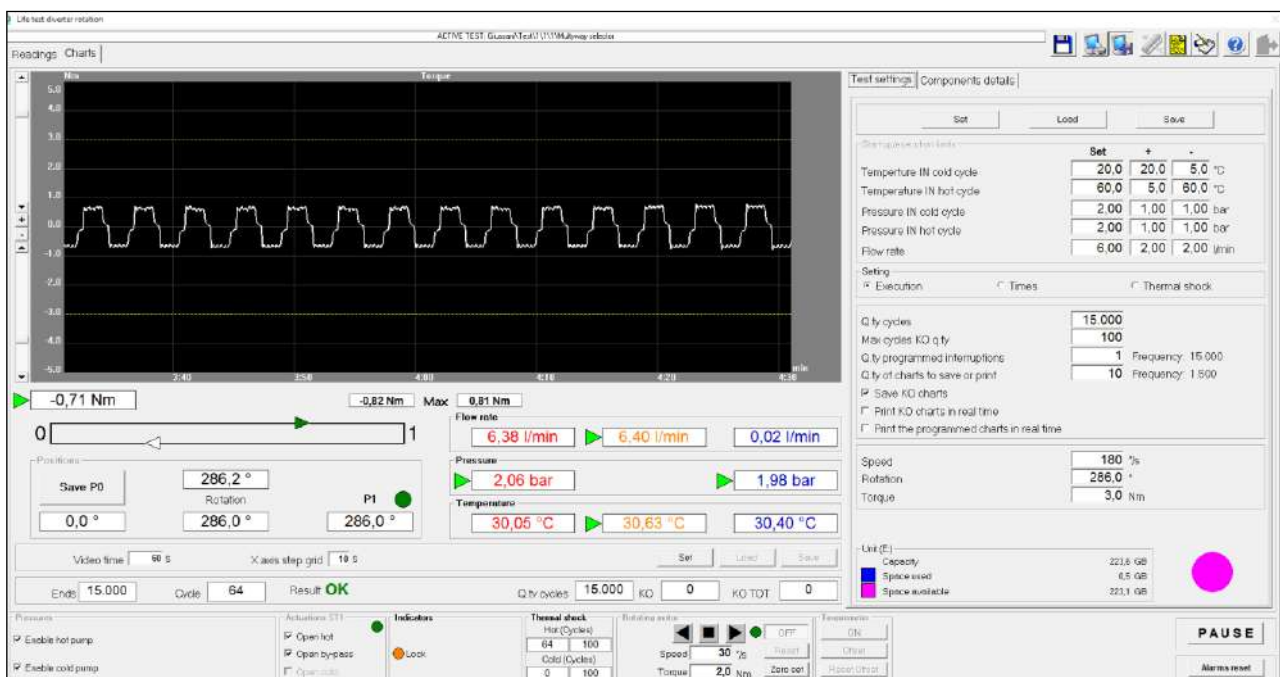
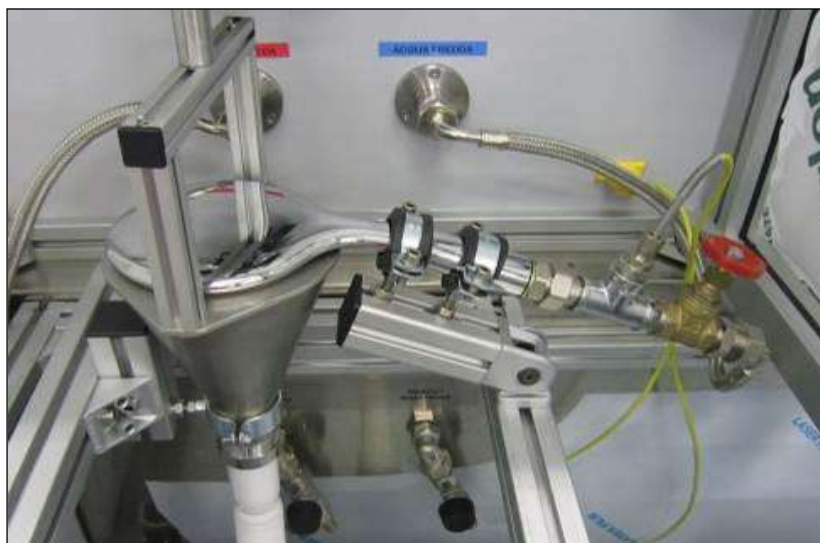

5 - OPTIONAL EQUIPMENTS, APPLICATIONS AND ACCESSORIES

5.1 - AQ2TB-COMBI-PR

Generic software for static pressure manual tests.

With this software is possible to check the leak tightness of the component under test pressurizing the plant with hydraulic multi-stages pump or hand pump without constrains in the test sequence. It allows to perform static test according to EN, NF and ASME/CSA Standards.

At the end of the acquisition, it is possible to save the data and generate a multi-language report.

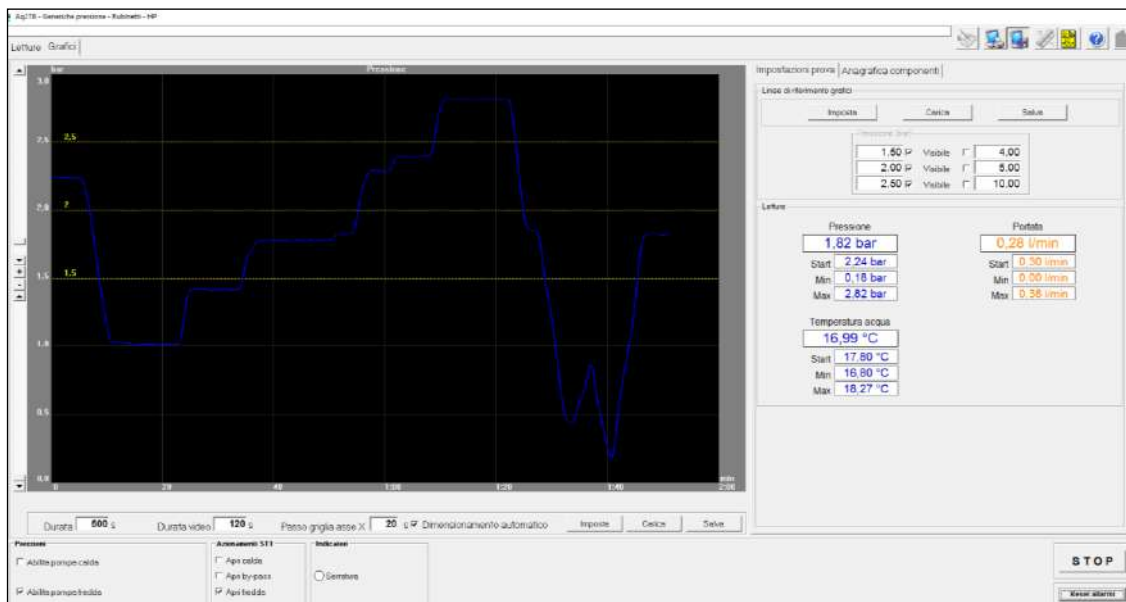

5.2 - AQ2TB-COMBILAB+

Basic software for the measure in real time of flow-rate, pressure and temperature in order to verify the reaction and the performance of components under test and to perform in addition pressure and temperature jumps tests, flow rate variation tests and temperature control variation test.

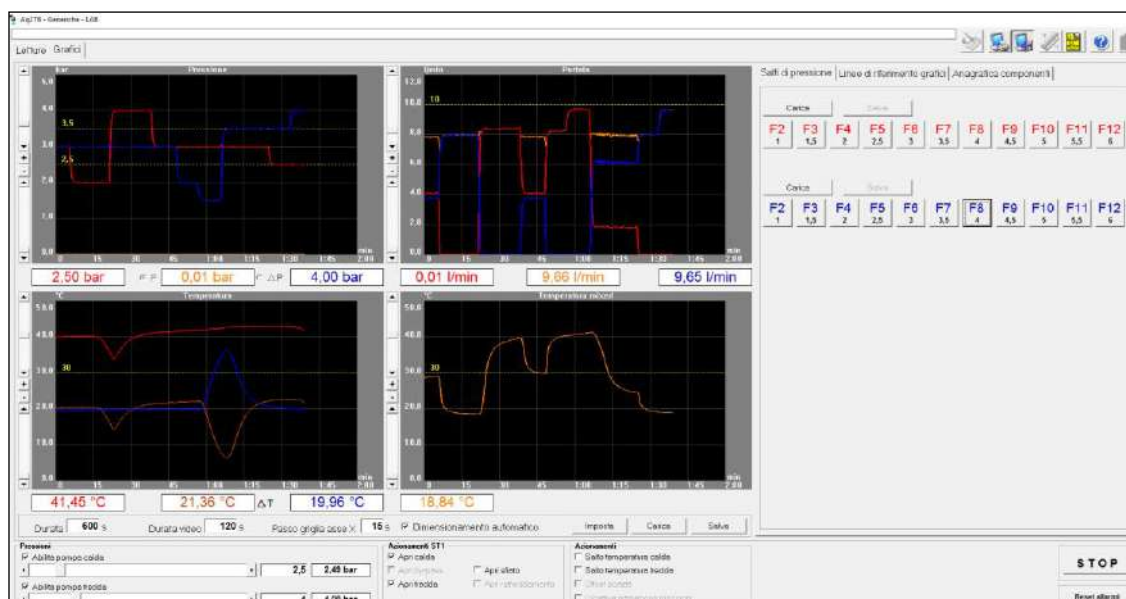

5.3 - AQ2TB-COMBI-LM

Generic laboratory software designed to perform, with the use of the linear motor, manual movements or simply programmable automatic movements sequences. The software allows the acquisition in real time of all the main physical quantities and it shows in graphic format, in addition to flow-rates and mixed water temperature, the force and the linear position and allows to perform the evaluations of the gotten results.

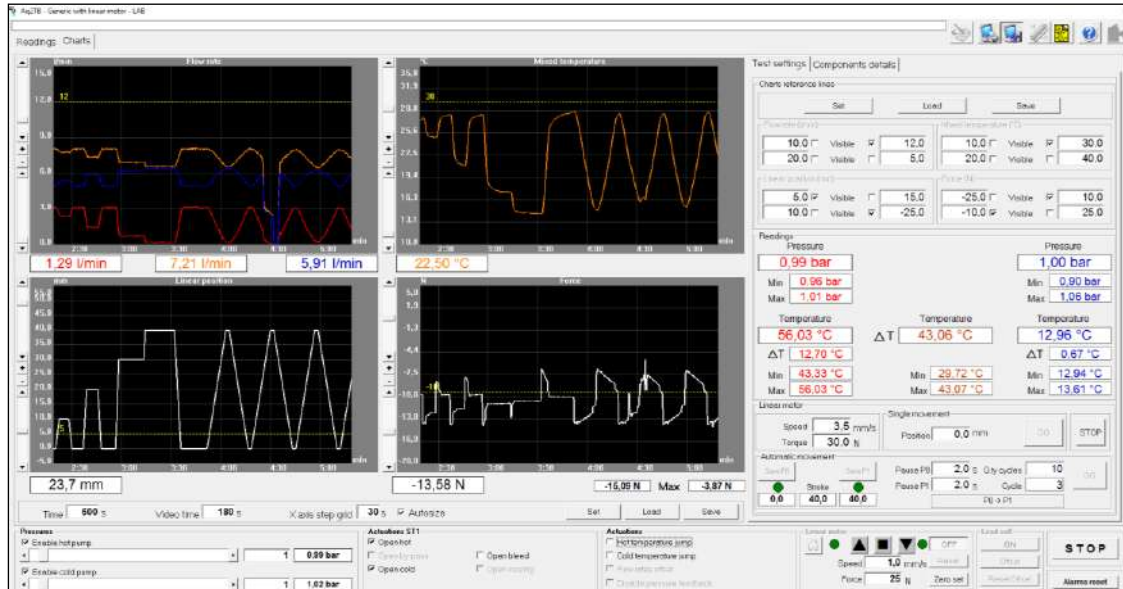

5.4 - AQ2TB-COMBI-RM

Generic laboratory software designed to perform, with the use of the rotary motor, manual movements or simply programmable automatic movements sequences. The software allows the acquisition in real time of all the main physical quantities and it shows in graphic format, in addition to flow-rates and mixed water temperature, the torque and the angular position and allows to perform the evaluations of the gotten results.

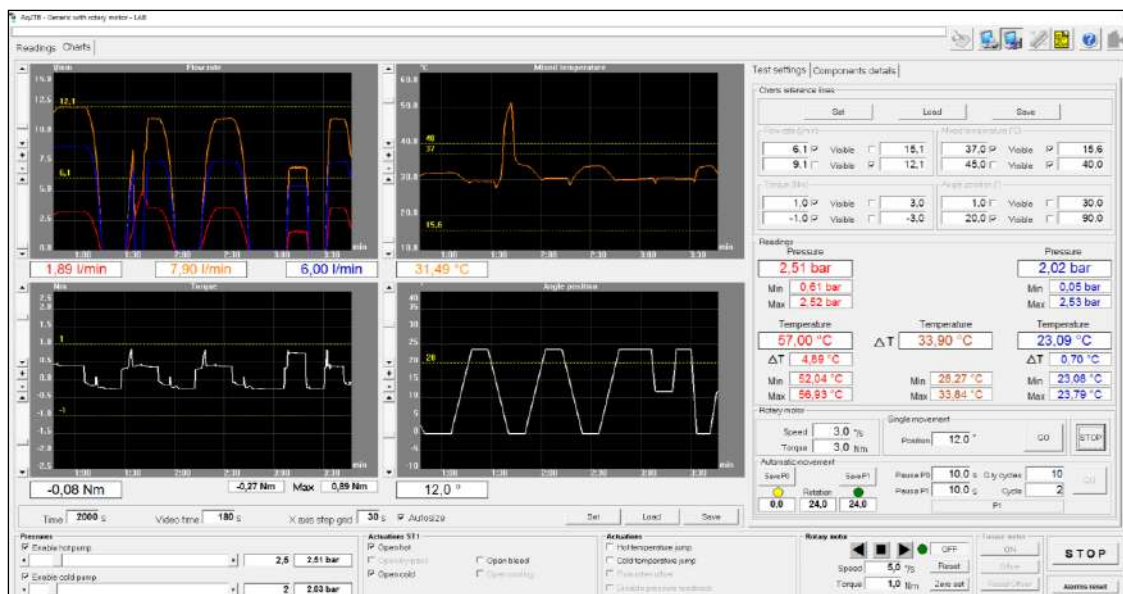

5.5 - AQ2TB-ASV

Software for the automatic execution of flow-rate tests on automatic shut-off valves according to EN 816 Standard. With this software is possible to measure the maximum flow-rate, the opening time, the outlet temperature, the total volume of water and evaluate the shape of flow-rate graph. Anytime is possible to reload a test report, change the calculation parameters and obtain different results.

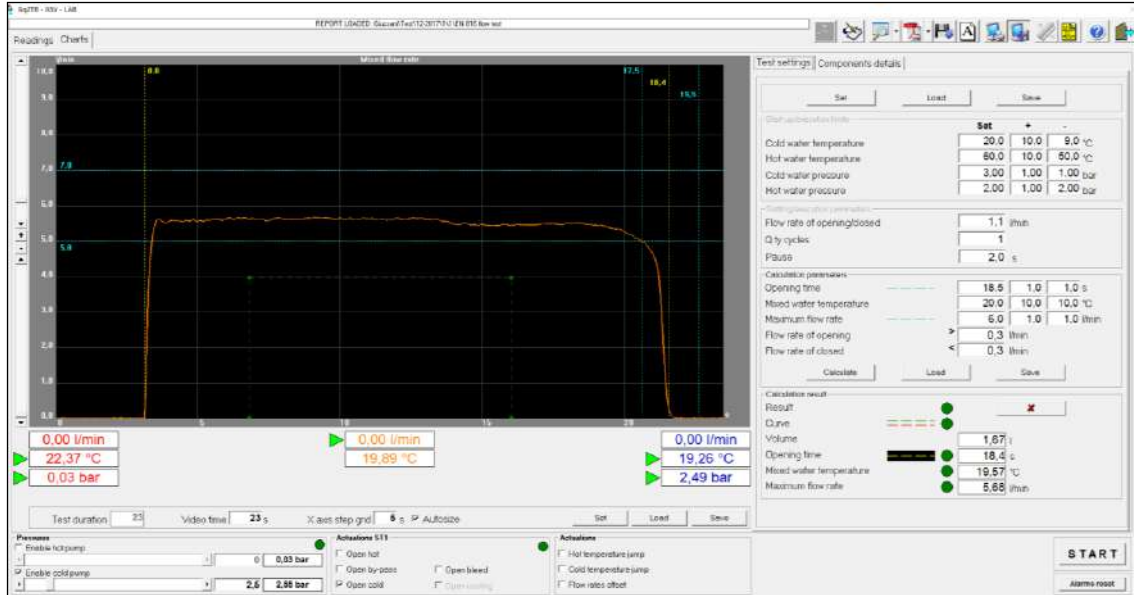

5.6 - Sensitivity and fidelity test

Code: BPR-OPZ-C-TM

Description:

Sensitivity and fidelity test for thermostatic and mechanical mixer according to EN and NF standards.

The movement system is used in order to verify the sensitivity and the fidelity of the mechanical and thermostatic mixers. It measures the minimum amplitude movement of the temperature control device required for a specific variation in the mixed water temperature, during the test the mixed water temperature is measured as a function of the angular position.

The procedure consists to move the temperature control handle from cold to hot position and return at controlled speed with stable water supply conditions.

The device includes the mechanical equipment necessary to connect the taps under test with the rotary motor.

Dedicated software including flow-rate measurement for mechanical mixers according EN817.

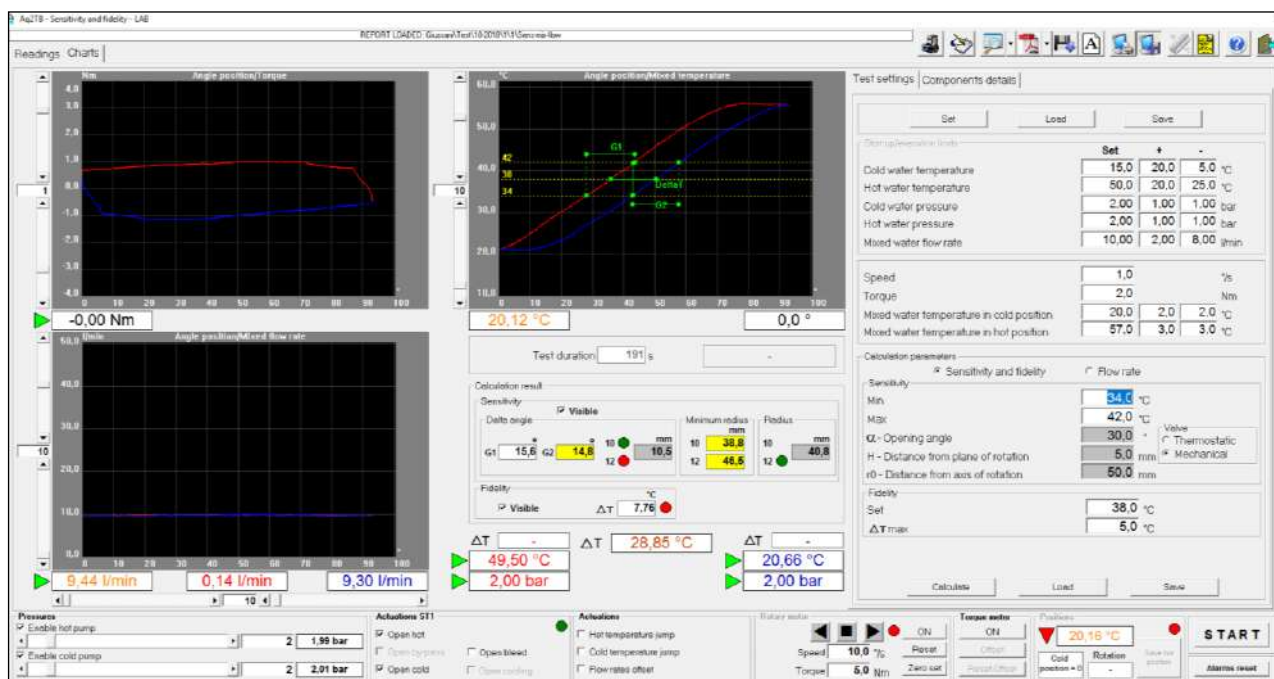
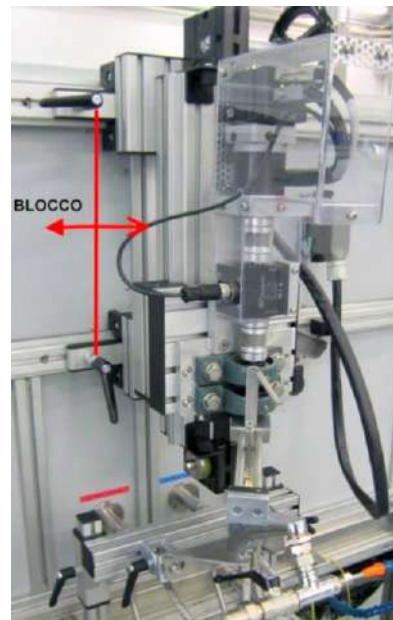

Installed software:

AQ2TB-F+S-DRIVE

Test code: SF01 - SF02



5.7 - BPR-OPZ-SL-FM

Rating ECAU – C2 classification

Description:

Device for measuring the force necessary to move the handle of mechanical mixers and the strength of hard point F2-F1 according to NF 077 TD077-03 rev.03 chap. 2.6.7.2 and 2.6.14 standard.

The system measures the torque and, using a simple mathematical calculation, shows the equivalent force to move the lever.

The software includes two multi-line graphs showing force and flow-rate as a function of the angular position and two graphs showing force and flow-rate as a function of time.

The system opens and closes the mixer five time measuring the opening force and showing the force variations together, in the same graph.

At the end of the acquisition is possible, by opening a relevant area with the ZOOM function, to measure the values F1 and F2.



Software: AQ2TB-SLFM

test code: SLFM

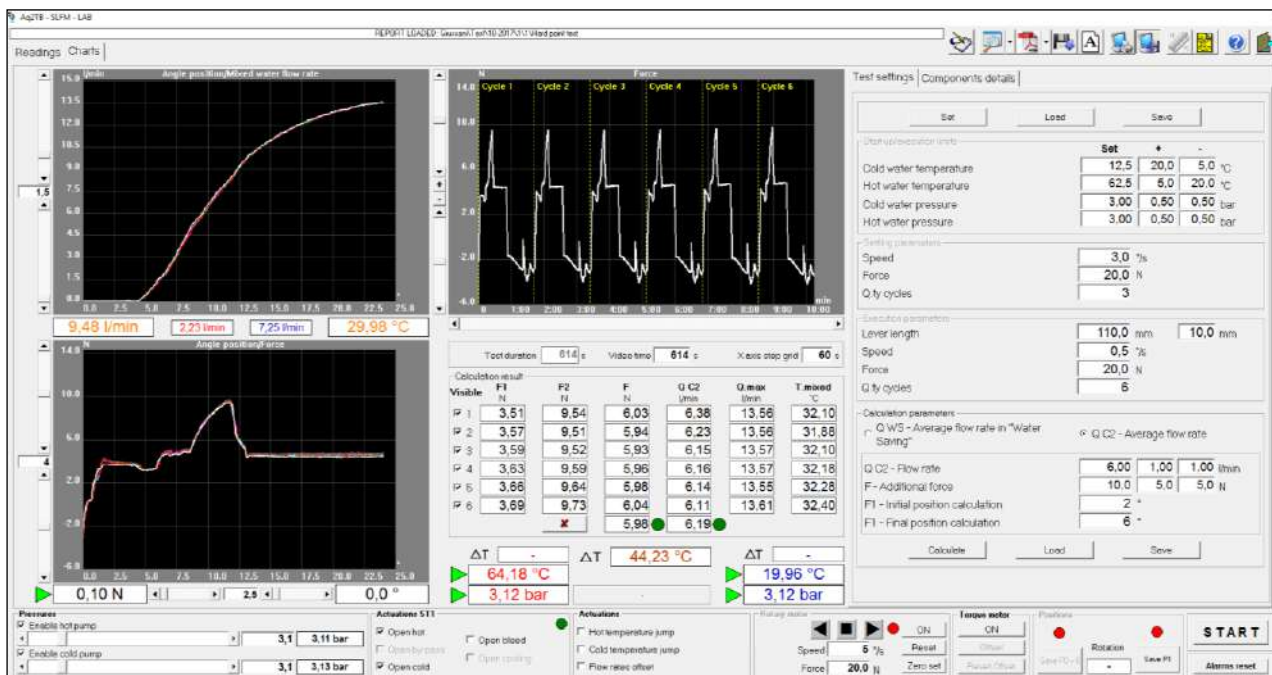

SOFTWARE FOR ENDURANCE TEST:

With this software, it is possible to perform the endurance test of the cartridge by opening, closing, and measuring the maximum resistant force each cycle.

Software: AQ2TB-SLFM-LIFE test code: SLFM-LIFE



5.8 - Thermal shock test

Code: BPR-OPZ-LH&C

Description:

Special equipment and dedicated software for thermal shock tests: this optional device allows to perform tests on showers, flexible hoses and generic devices alternating cold and hot water.

Installed software:

AQ2TB-1LD-H&C

Test code: TS01

Life test software according to standards EN 1112, EN 1113 and NF 079 doc.8.

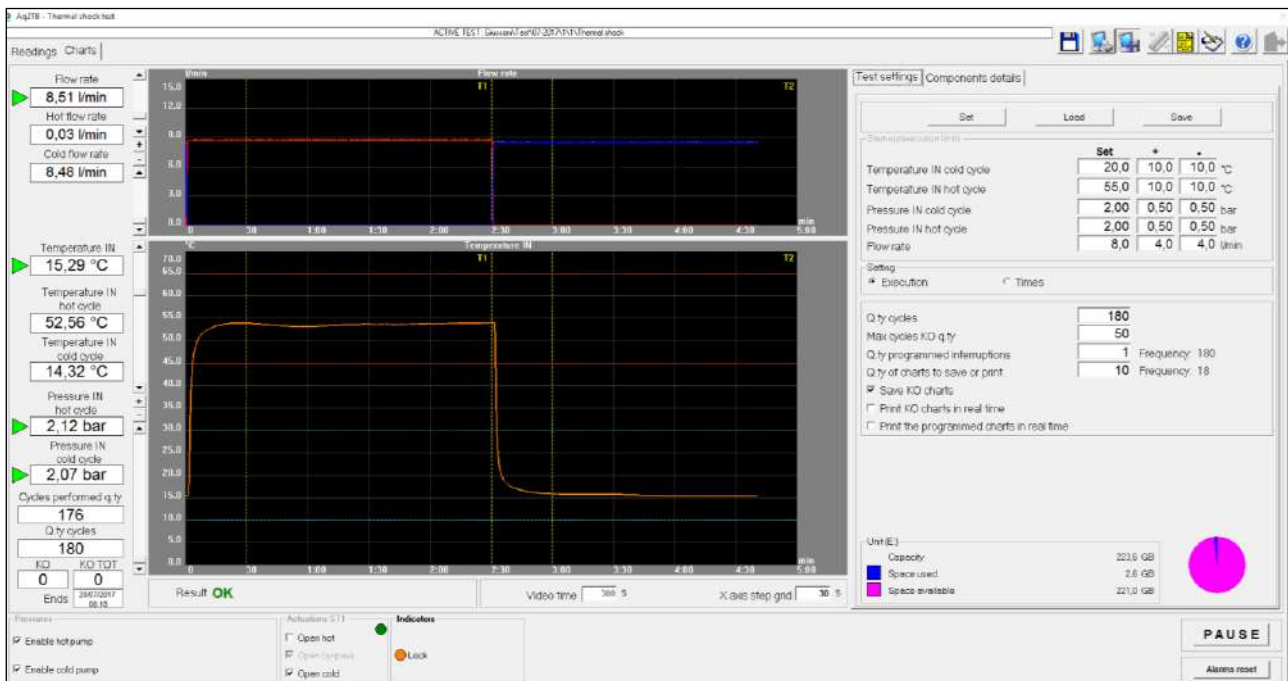

Software on request:

AQ2TB-1LM-H&C

Test code: ETV01

Life test software according to standards EN 1111 (2017) chap. 16.8.3 and EN 15092 chap. 7.10.

5.9 - Pressure resistance at elevated temperature

Code: BPR-OPZ-LSH

Description:

Special equipment and dedicated software for testing the pressure and temperature resistance of hoses at the upper limits of use.

Installed software:

AQ2TB-LSH

Test code: PRH01

Life test software according to standards EN 1113 chap. 9.4 and EN 16146 chap. 9.5.

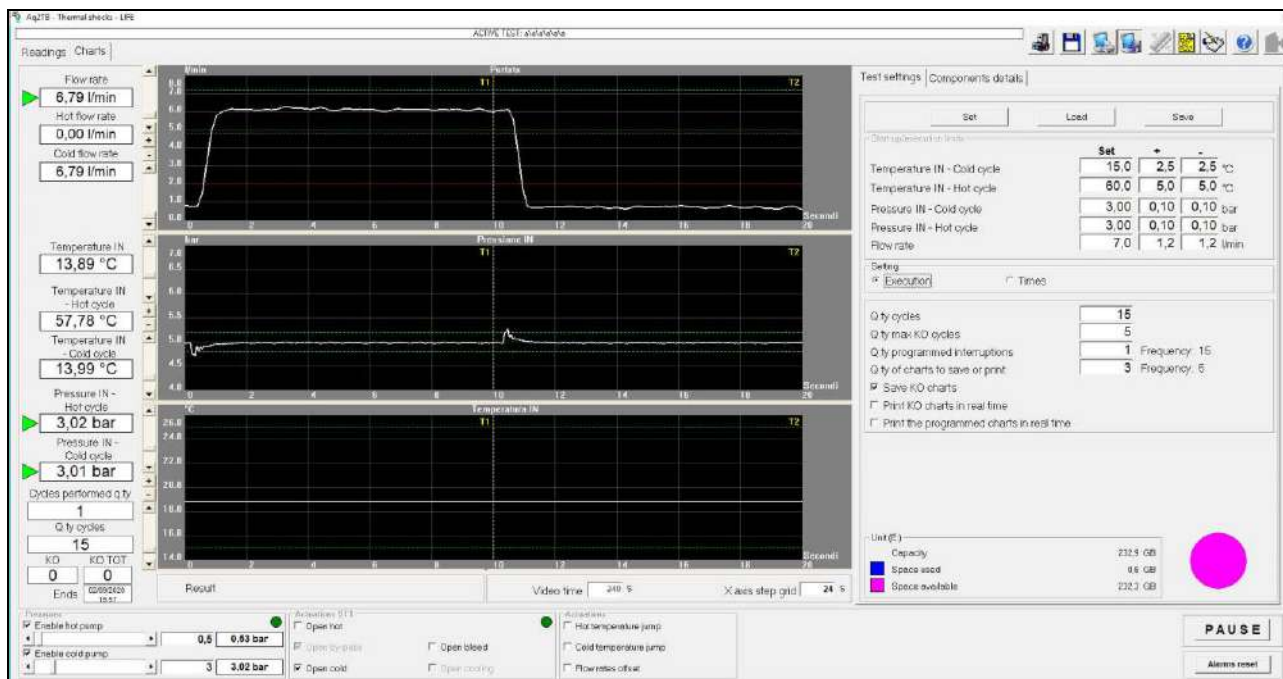

5.10 - Mechanical strength characteristics

Code: BPR-OPZ-FM

Description:

Special mechanical equipment to carry out a test to verify the torsional strength of the operating mechanism of mechanical mixing valves according to EN 817 (chapter 11).



AQ2TB-COMBI-FM

Generic software for the measure of the force generated by the OPZ-FM device and conversion, through parameters chosen by the user, in torque as requested by the standards.

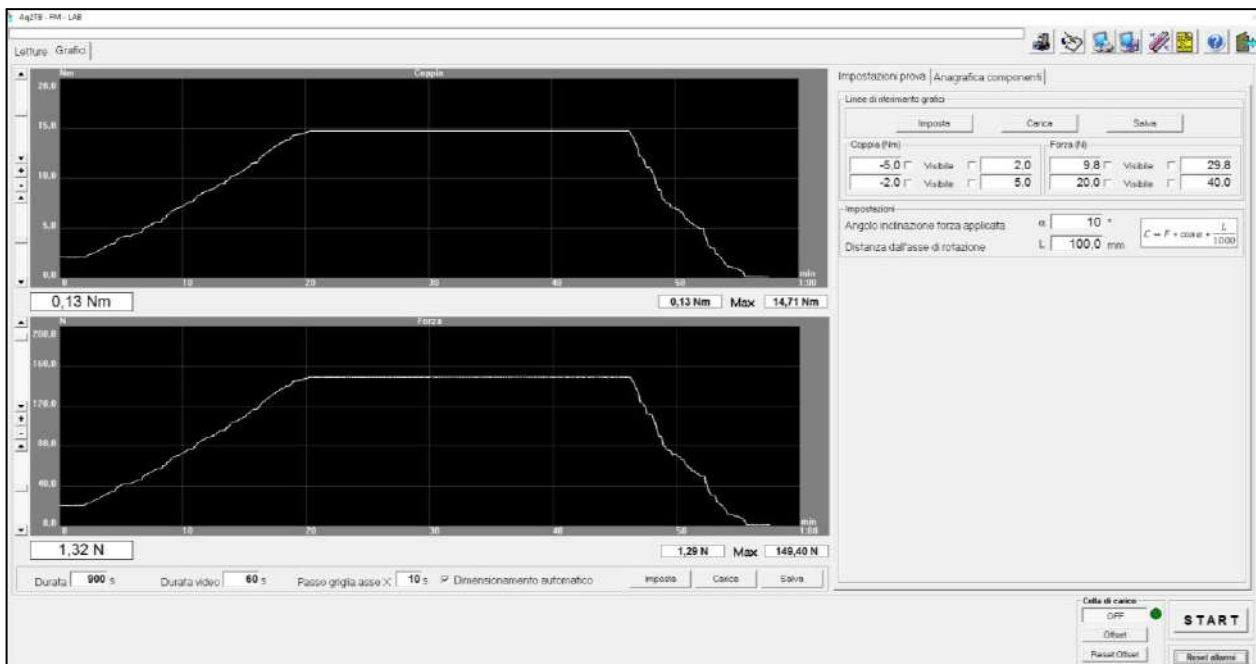

5.11 - AQ2TB-ASTD

Description:

Software for checking the peak temperature for the temperature setting variations of the thermostatic mixers, carried out with torque motor.

Standard reference:

EN 1111 (2017) chapter 13.5.1.

With this software is possible to set up to 10 steps of angular position. For each steps is possible to select the angular speed and the waiting time.

The acquisition graph shows the angular position and the mixed water temperature. Supply temperatures, pressures and flow-rate are controlled continuously.

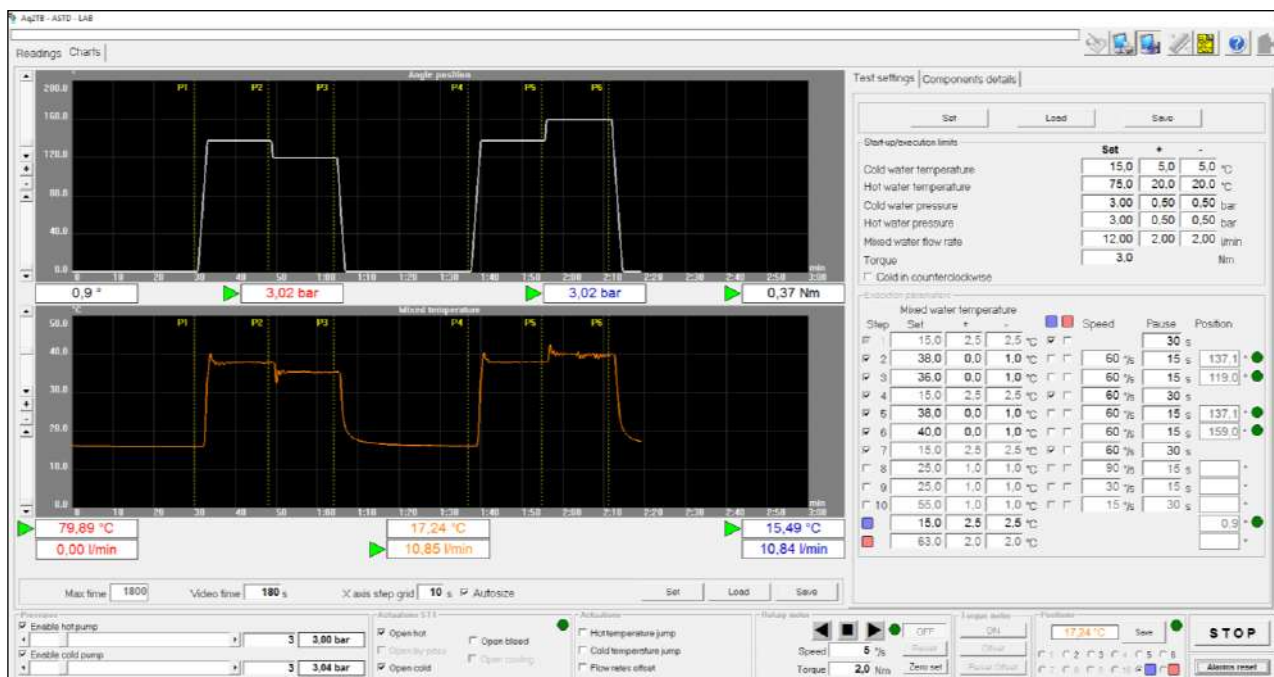
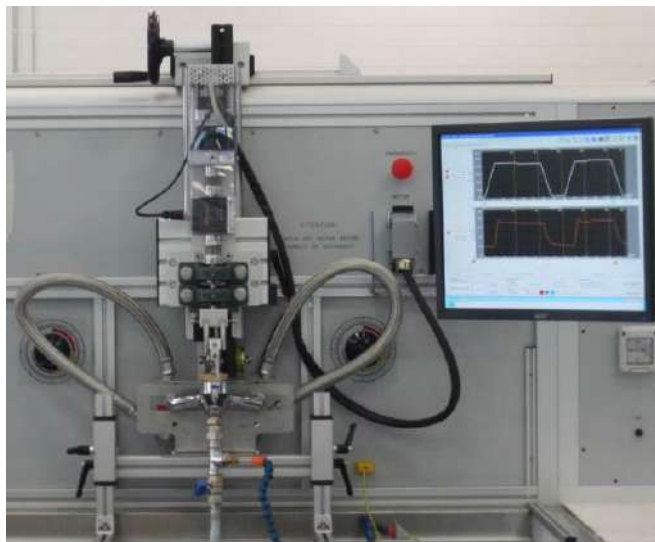

Software: AQ2TB-ASTD test code: ASTD01

5.12 - **BPR-OPZ-ES01**

Description:

Electrical supply to connect electro-valves or other electronic equipment under test; it includes:

- Three electrical sockets: 230 V AC – 230 V AC – 24 V DC.
- All the socket are protected by an isolation transformer and safety push bottom.
- Variable power supply 0-30 V DC, 0-5 A, with digital indication of voltage and current.



5.13 - **KIT OF SUPPORTS**

Accessories for installation of faucet: see below detailed description

Code: KITSUPPORTI-LIFE2

- **Adjustable universal holder**

With possibility of vertical regulation, adjustable rotation (0 ÷ 180 °) and blocking levers (Fig. 1)



- Universal taps support platen (Fig.2)



- Kit of fittings including reductions, nipples, caps, gaskets and screws according the configuration of the test bench. **Code: SERV.KIT-RUB.PN10**
Note: includes kit of hand tools comprising adjustable wrench, screwdrivers, hex key and hydraulic key. **Code: 2FRGKIT.UT**

5.14 - KIT OF ACCESIORES FOR ROTARY MOTOR

Kit of accessories and supports for the installation of the devices under test and the connection to the motors and to the water supply.

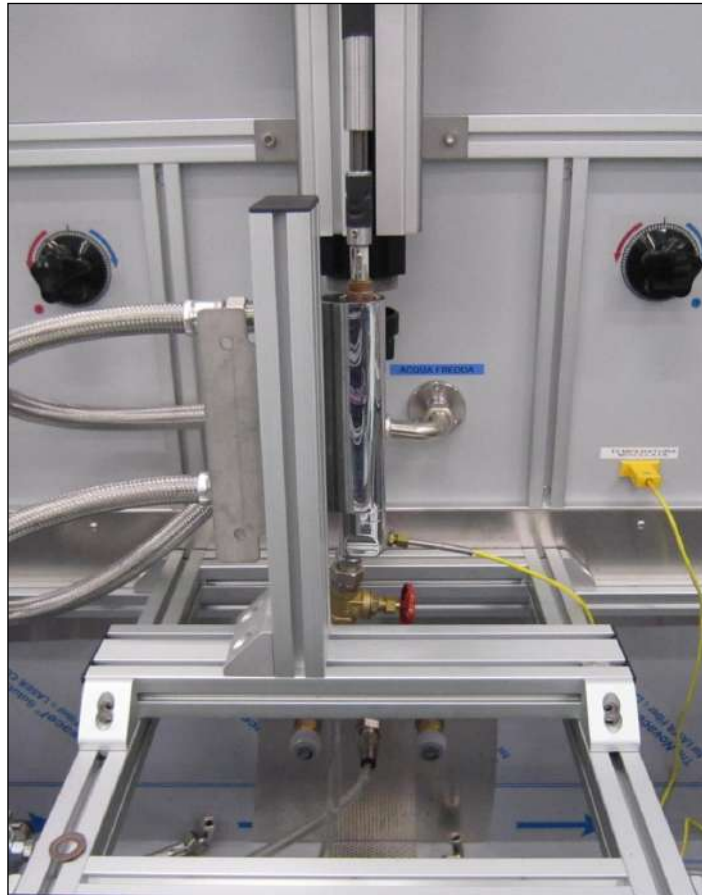

Includes:

- Working tank square supporting frame.
- Aluminum “L” supporting frame.
- Universal joint.
- Water supply flexible hoses.
- Adjustable universal holder.
- Universal taps support platen.
- Suitcase.

Code: **KIT-ACC-ROTMOT**

Note: this option requires **KITSUPPORTI-LIFE2** device.

5.15 - SPARE PARTS KIT

The spare parts kit includes transducers, valves, fuses, lamps according to the configuration of the test bench.

Code: SPARE-PARTS

Note:

Basic kit including TcK probe, fuses and lamps provided with the test bench.

(Code: **SPARE-PARTSBASIC-RL**)

6 - WATER SUPPLY

IMPORTANT: to supply the bench with cold and hot water there are two possibilities:

- 1) By the customer plant (that provide hot and cold water): in this way it is necessary to install two tanks between the external plant and the bench.**
- 2) The test bench is supplied by the hot and cold water generator TCW B2 with closed circuit (reference chapter 6.1 and 6.2).**

6.1 - TCW B2

Hot and cold water supply generator

The TCW water generator allows to supply continuously, in closed circuit, the sanitary taps test bench. It is equipped with two 300+300 L tanks for hot and cold accumulation.

Heating power: 24 kW, three heating resistances 8+8+8 kW, hot water range: 40÷90 °C.

Cooling power: 23 kW, scroll type compressor, cold-water range: 10÷25 °C.

PLC for faults controller and Ethernet communication with the test bench.

Flow rate in continuous mode: 12+12 L/min of water at 65±1 °C and 15±1 °C.

Size: 1200 x 2300 x (h) 2050 mm.

Weight: 680 kg (approx.).

Electrical supply: 400 V - 50 Hz.

Power: 36,0 kW.

Filling from customer supply plant.

CODE: TCWB2NMSBXGS200

Note: special models are available for applications that require higher cooling or heating power.

Note: special models are available for different power supply (extra Europe market).

KIT-FILTROBWT water treatment to reduce the hardness and contamination of water supply, including mechanical filter and flow counter.

Weight: 6,0 kg – Filtering capacity: 8100 L at 17 °f (10 °d).

Note: special models are available.

KIT-FILTRO-OPUR for the filtering of the water recovered from the bench; N°2 high temperature filters, size 1-1/4", 300 µm, maximum filtering flow-rate 5,5 m³/h. Includes manometers for the control of the correct functioning.

6.2 - BPR-OPZ-HCR

This device is connected to the water drained from the bench and is equipped with two pneumatic ball valves, controlled by a temperature probe, to separate and collect the water in two different tanks depending of the temperature.

Two pumps convey water in the tanks inside the TCW B2 generator.

This equipment saves water and energy.

Size: 450 x 550 x (h) 500 mm.

Electrical supply: 240 V - 50 Hz.

Power: 1,5 kW.

Weight: approx. 80 kg.

Packing included into the other box.

7 - PACKAGING

7.1 - BPR-2L-VM-SWG packaging

Wooden box with anti-vibrating damper.

Exp. model with sealed plastic bag and ISPM treatment.

Code: 8CASSABPR300EXP

7.2 - TCW B2 packaging

Wooden box with anti-vibrating damper.

Exp. model with sealed plastic bag and ISPM treatment.

Code: 8CASSATCWB2-EXP

7.3 - Accessories packaging

Wooden box with anti-vibrating damper.

Exp. model with sealed plastic bag and ISPM treatment.

Code: 8CASSA-WORKT

8 - EXAMPLE

Base model with protection cover (optional)

