

# BPF

## HYDRAULIC TEST BENCHES CONFIGURATION 2024

### INDEX

<b>1 - INTRODUCTION</b> .....	<b>3</b>
<b>2 - BASE MODELS</b> .....	<b>5</b>
2.1 - BPF100-SI .....	5
2.1.1 - Applications: .....	5
2.1.2 - Basic software installed: .....	6
2.1.3 - Ethernet connection:.....	7
2.1.4 - Main components: .....	7
2.1.5 - PC and software:.....	8
2.1.6 - Structural characteristic of the bench:.....	9
2.1.7 - Transducers installed:.....	10
2.1.8 - Technical data: .....	10
2.2 - BPF250-SI .....	11
2.2.1 - Dedicated components:.....	11
2.2.2 - Dedicated transducers: .....	11
2.3 - BPF400-SI .....	11
2.3.1 - Dedicated components: .....	11
2.3.2 - Dedicated transducers: .....	11
2.4 - BPF600-SI .....	12
2.4.1 - Dedicated components:.....	12
2.4.2 - Dedicated transducers: .....	12
<b>3 - ADDITIONAL SOFTWARE</b> .....	<b>13</b>
3.1 - ADDITIONAL SOFTWARE FOR TESTING.....	13
3.2 - SERVICE FUNCTIONALITIES .....	14
3.3 - AQ2TB-MANSYS.....	15
<b>4 - ADDITIONAL EQUIPMENT</b> .....	<b>16</b>
4.1 - BPF-OPZ-C50-12 .....	16
4.1.1 - Operative range: .....	16
4.1.2 - Applications: .....	16
4.1.3 - Dedicated components:.....	16
4.1.4 - Dedicated transducers: .....	17
4.1.5 - Dedicated software:.....	17
4.1.6 - Technical data: .....	18
4.2 - BPF-OPZ-Q100 .....	19
4.2.1 - Operative range: .....	19
4.2.2 - Applications: .....	19
4.2.3 - Dedicated transducers: .....	19
4.2.4 - Additional software installed:.....	20
4.2.5 - Dedicated components on request: .....	21
4.2.6 - Applications: .....	21
4.2.7 - Additional software installed on request: .....	21
4.3 - BPF-OPZ-HT .....	22
4.3.1 - Operative range: .....	22
4.3.2 - Applications: .....	22
4.3.3 - Dedicated components:.....	22
4.3.4 - Technical data: .....	23
4.4 - BPF-OPZ-HC.....	24
4.4.1 - Operative range: .....	24
4.4.2 - Dedicated components: .....	24
4.4.3 - Technical data: .....	24
4.5 - BPF-OPZ-TC .....	25
4.5.1 - Operative range: .....	25
4.5.2 - Applications: .....	25
4.5.3 - Dedicated components:.....	25
4.5.4 - Additional software installed: .....	26
4.5.5 - Technical data: .....	26

<b>5 - OPTIONAL DEVICES.....</b>	<b>27</b>
5.1 - BPF-OPZ-PM .....	27
5.2 - BPF-OPZ-VAC.....	27
5.2.1 - <i>Dedicated components:</i> .....	27
5.2.2 - <i>Burst test sequence with OPZ-VAC:</i> .....	27
5.3 - CHILLER OPTION .....	28
5.3.1 - <i>Applications:</i> .....	28
5.3.2 - <i>Technical data:</i> .....	28
5.4 - BPF-OPZ-DELTA-L.....	28
5.5 - BPF-OPZ-EXT-OUT .....	28
5.6 - SPARE PARTS KIT.....	28
5.7 - FITTINGS KIT .....	28
<b>6 - PACKAGING .....</b>	<b>29</b>
6.1 - BPF PACKAGING (LENGTH 2000 MM) .....	29
6.2 - BPF PACKAGING (LENGTH 2300 MM) .....	29
6.3 - BPF PACKAGING (LENGTH 2400 MM) .....	29
6.4 - BPF PACKAGING (LENGTH 2700 MM) .....	29
6.5 - BPF PACKAGING (LENGTH 3000 MM) .....	29
6.6 - BPF PACKAGING (LENGTH 3000 MM - TC) .....	29
6.7 - ACCESSORIES PACKAGING.....	29
<b>7 - EXAMPLES.....</b>	<b>30</b>

# 1 - INTRODUCTION

## APPLICATIONS:

The BPF series test benches have been designed to carry out single hydraulic test or life test of fitting, multilayer tubes, flexible tubes, plastic tubes, valves, heat exchanger and many others hydraulic components by readings and measurements the hydraulic characteristics in real operative conditions. The bench are designed to simulate pressure variation with possibility to adjust the water temperature and air chamber temperature, the test are performed according the Standards.

Examples of components that is possible to test with BPF benches:

- Flexible hoses, plastic tubes, multi-layers tubes, tube/connections assembly.
- Connections and hydraulic/pneumatic couplings.
- Valves, heat exchangers, plastic and metallic devices, hydraulic components.

The BPF benches allows to generate static and pulsing pressure with hot and cold water and allows to control the temperature of the test chamber in order to perform tests according to the main International Standards.

Optional devices are available to perform flow-rate tests, thermal cycles tests and other specific tests.

## TEST EXECUTABLE:

- Static and burst tests, pulsing and cyclical pressure tests.
- Flow-rate tests and Kv coefficient calculation.
- Endurance with thermal cycles.
- Endurance with thermal cycle and cyclical pressure combined.

## MODELS AVAILABLE:

### BPF<sup>AAA</sup>-B<sup>BBB</sup>-C<sup>CC</sup>-D<sup>DDD</sup>

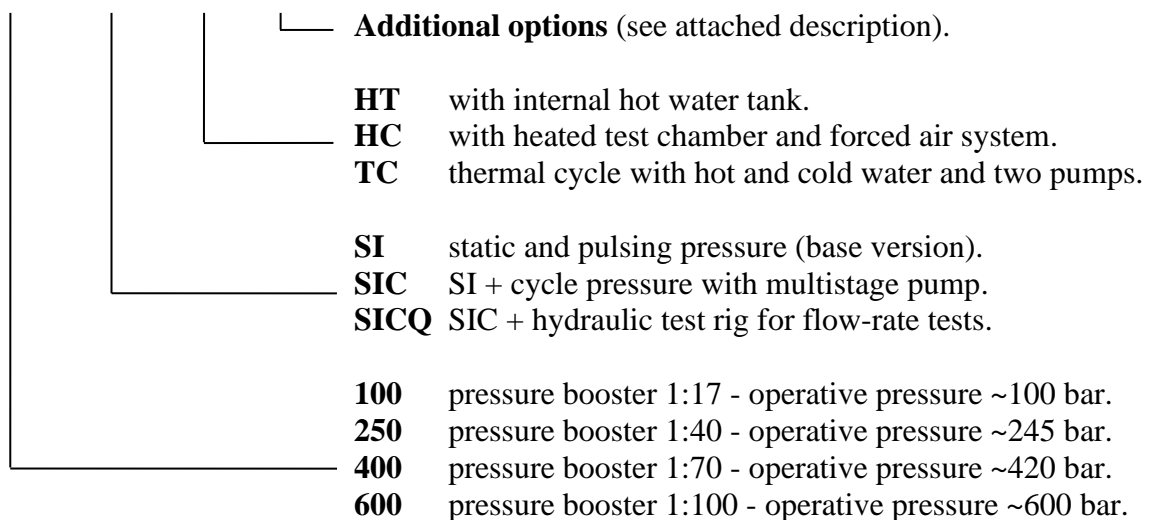

\*NOTE: the operative pressure is the maximum reachable value with air pressure supply at 7 bar.  
The test bench is projected to resist to a supply pressure of 10 bar and to a working pressure of 9 bar.

#### **ADDITIONAL OPTIONS AVAILABLE:**

- OPZ-C multistage vertical pump for pressurization and cold water tank.
- OPZ-Q test rig for flow-rate measurement available only with OPZ-C option.
- OPZ-HT internal thermostatic tank to perform tests with hot water up to 93 °C.
- OPZ-HC test chamber with heating system and controlled temperature up to 110 °C.
- OPZ-TC test rig with hot and cold tanks and two supply pumps to perform thermal cycle tests.

#### **ADDITIONAL EQUIPMENTS AND ACCESSORIES:**

- OPZ-PM device for initial pressurization with hand pump.
- OPZ-VAC vacuum pump and accessories to evacuate air from the component under test.
- CHILLER external equipment for cooling of cold water.
- OPZ-DELTA-L device for dilatation measuring during the static pressure test.
- OPZ-EXT-OUT external outlet to perform static and pulsing test outside the test chamber.

## 2 - BASE MODELS

### 2.1 - BPF100-SI

- Maximum project pressure: 140 bar.
- Static pressure (without water circulation): 1÷100 bar.
- Burst pressure (without water circulation): 1÷100 bar.
- Pulsing pressure (without water circulation): 1÷100 bar.
- Maximum temperature of external supply water: 10÷60 °C.

#### 2.1.1 - Applications:

It is possible to perform static, burst and pulsing pressure tests.

#### Code: P01

##### Static pressure:

with the component under constant pressure, maximum pressure 140 bar, adjustable rising and falling pressure slopes. component under test connected and filled with cold or hot water from external plant. Pressure increase and stabilization by booster.

*Modality:*

*Number of pieces under test:*

1.

*Example of Standard reference:*

DVGW W543 5.5.7 - UNI 9028 10.3.2.4 - CEI EN 50084 8.6  
KIWA BRL-K622/01 - EN 13618 B2-B4.

#### Code: P02

##### Pulsing pressure:

component filled with cold water, maximum pressure 100 bar, maximum frequency 1 Hz.

*Modality:*

water hammer test cycles generated by booster with adjustable range up to 100 bar and 1 Hz maximum frequency.

*Number of pieces under test:*

1-4.

*Example of Standard reference:*

NF 077 - DVGW W543 5.5.8  
EN 13618 B.5 and B.6 – UNI 9028 10.3.2.6

#### Code: P04

##### Burst:

performed with cold or hot water from external plant and maximum operative pressure 140 bar.

*Modality:*

component under test connected and filled with cold or hot water from external plant. Pressure increase, stabilization and final rising made by booster.

*Number of pieces under test:*

1.

*Example of Standard reference:*

UNI 9028 10.3.2.1 - KIWA BRL-K622/0

### 2.1.2 - Basic software installed:

- A) AQ2TB-BASEMOD** “SWG” service software with multichannel acquisition engine, management of users, calibration, change of units of measure, change of language, messages, water and air temperature regulation (if available on the bench).
- B) AQ2TB-STATICAUT** Automatic software for leak-tightness tests on sanitary taps, flexible hoses and generic hydraulic components. The software allows to perform up to 10 stabilization steps with adjustable times and rising/falling ramps customizable. It allows also the check of the maximum pressure before the burst of the component.

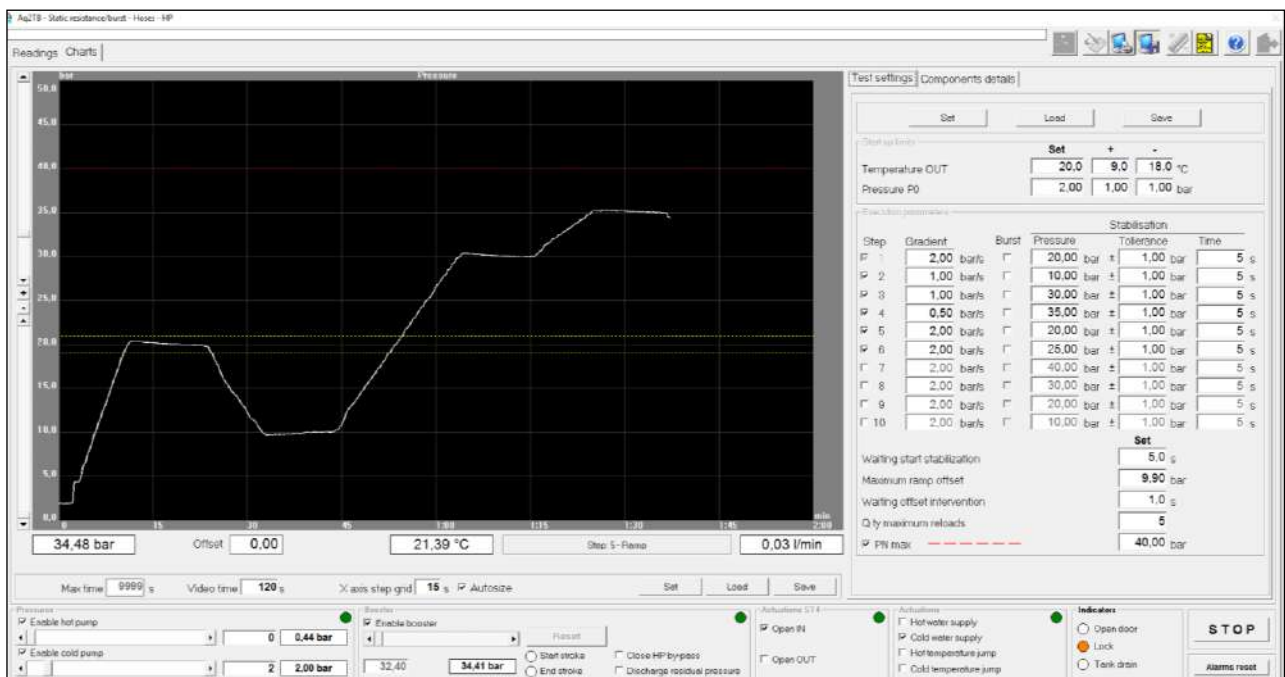
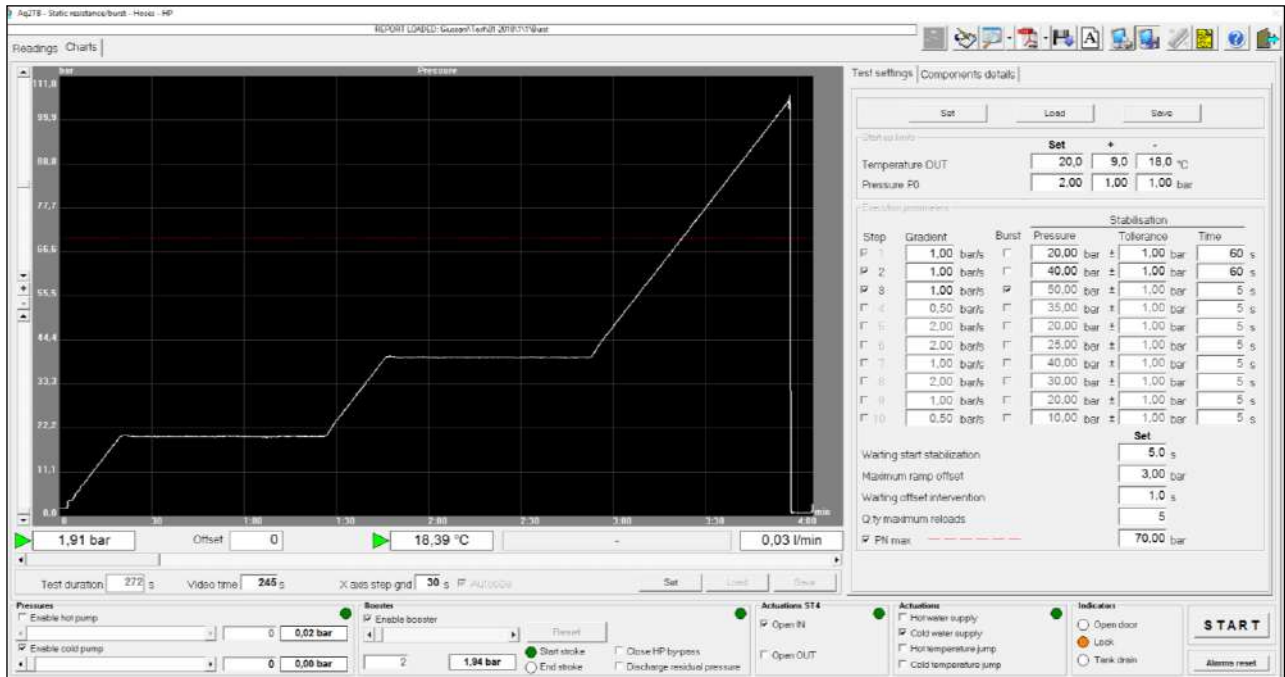

- C) AQ2TB-PULSEAUT** Automatic endurance software for pulsing pressure tests (check of water hammer resistance). It is possible to set the number of cycles, minimum and



maximum pressure, pulsing frequency, and cycle times. Control in real time of pressure and check of the water temperature for test performed with water circulation.

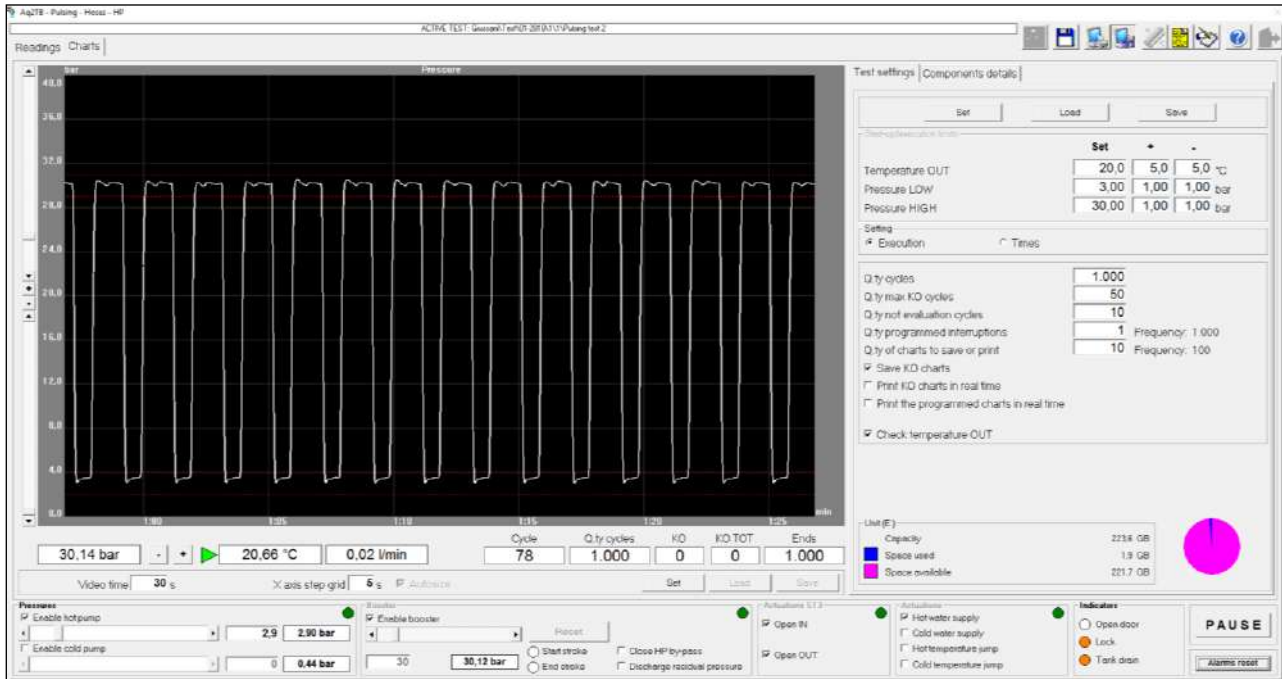

**Note:** the functionalities of the software may vary according the configuration of the test bench.

- D) **WINDOWS 10** OEM Multilanguage.
- E) **MACRIUM BACKUP** software for automatic back up of test data and operative system.
- F) **SOMACHINE** software for management of PLC.
- G) **TEAM VIEWER** internet remote control.

**Basic software included is in Italian language + second language English or German. Others languages only by request with extra cost.**

### 2.1.3 - Ethernet connection:

The test bench is provided with Ethernet plug in order to allow the connection to Internet and enable the remote assistance functionalities through TEAMVIEWER software (installed by default on the PC).

The Ethernet plug also allows the integration of the bench inside the customer's network (intranet). In this way is possible to export data and reports and remotely check the functioning of the bench.

It allows, in conjunction with AQ2TB-MANSYS software, the incoming (from corporate server to test bench) and outgoing data exchange (from bench to server).

### 2.1.4 - Main components:

- **Pressure intensifier (booster) with ratio 1:17 approx.** The pressure generated with 6 bar of air supply is about 100 bar. The booster is provided with a pneumatic control plant including

electro-pneumatic converter, high-pressure supply valves, filtering and lubricating devices and pressure transducers with high dynamic response.

**Operating mode:** the booster is equipped with magnetic limit switches; when the piston reaches the upper end stroke, the system inverts the pneumatic supply of the booster. It returns to the beginning of the stroke carrying out a new filling of the pressurization chamber. Then, the system inverts again the pneumatic supply of the booster to continue the pressurization up to the set value or until the burst.

- **Water supply plant from external network** with cold or hot water, pneumatic valves and temperature probe.
- **Testing area approx. 900 (1300) x 500 x (h) 1000 (500) mm** with dedicated outlets in frontal position for burst and water hammer tests. The testing area is provided with a stainless steel tank for the recovery of the water with overflow and drain tubes. The drain is provided with closure valve and level switch in order to stop the test in case of failure of the components. Safety door made of profiled aluminum bar with double polycarbonate protection and safety lock device operatives during the tests.
- **High-pressure test rig** made by stainless steel tube DN 10 mm and pneumatic ball valve for medium pressure.
- **Collector for pulsing pressure tests** with fixed bar equipped with 4 threaded connections placed horizontally and one mobile bar placed on a carriage to adapt to the different lengths of test hoses. The collector is equipped with 4 threaded connections placed horizontally and tilted with stainless steel unions with conical seat and Viton OR seal. The collector can freely run on tracks or be locked in place.
- **Collector for burst tests** includes an outlet with stainless steel union with conical seat and Viton OR seal and a mobile collector mounted on carriage to adapt itself to the different lengths of the test hoses. The collector can freely run on tracks or be locked in place.

### **2.1.5 - PC and software:**

#### ***Installed WORKSTATION consisting of:***

- **Intel processor** – the configuration changes according the last components in the market: acquisition card National Instruments, network cards, two hard disks, DVD burner.
- **Keyboard and mouse wireless.**
- **A4 colour laser printer and support trolley – Code: KIT-LASERPRINTER.**
- **23” LCD monitor 16:9, assembled on adjustable holder.**
  - Available on request **Touchscreen monitor - Code: 4MONITOR23-TS.**
- **UPS power supply 500 W.**
- **Back-up external unit – USB HDD.**
- **Instruction manuals and Help on-line.**



### ***Operative system and acquisition software SWG:***

- Operative system: **Windows 10 Enterprise LTSC**.
- **Dedicated software: SWG 2024** to perform hydraulic tests.  
The new multilanguage software SWG allows to work with different units of measure, it allows to acquire the parameters for the functioning of the bench and to provide documentation for the tests through the following screens:
  - ◇ Start-up screen with several options available: the account (admin/users) and passwords management, calibration, transducers check, selection of software language, units of measure, messages and software for the execution of the tests.
  - ◇ Main screen showing the virtual synoptically panel, with all the measures acquired in real time.
  - ◇ Specific screen showing pressure in graphic format with adjustable video size, possibility to perform enlargements of the working area, final summary data with the minimum, maximum and average values at the end of the acquisition.
  - ◇ Final report with all the test data and a significant video screen. It is possible to generate each report in different languages.
  - ◇ It is possible to control the opening and closing of all the internal valves and the pumps by clicking with the mouse on the graphic symbol representing each components in the synoptic panel.
  - ◇ All the existing screens may be printed with customer's notes and logo.
  - ◇ Help On-line support, with all the main operational instructions.

### ***2.1.6 - Structural characteristic of the bench:***

- Supporting structural frame made of aluminum and laminated panels.
- Safety door made of profiled aluminum bar with double polycarbonate protection and safety lock device
- Rails made of anticorodal section for the fixing of equipment under test.
- Assembly on rotating wheels provided with parking brakes.
- Internal hydraulic plant for the supply of hot and cold water, made with thermally insulated piping.
- Working tank in stainless steel (1,5 mm) with drain.
- Valves installed on hydraulic plant with pneumatic actuators.
- Internal separation between hydraulic plant and the area with PC and electrical cabling.
- Double-stage air filter unit.

### 2.1.7 - Transducers installed:

TEMPERATURE: accuracy  $\pm 0,3$  °C, resolution 0,01 °C.  
Pt100 low-inertia, 3-wires probes.

PRESSURE: operative range 0-250 bar.  
accuracy  $\pm 0,10\%$  of the full-scale value.  
resolution 0,01 bar, pressure probes with high dynamic response.

**The measuring equipment assembled on the bench is equipped with an inspection report relative to the operational fields and performed according to the ISO 9001 standards, with reference to the *Accredia* (Italian Calibration Service) primary samples.**

**The test bench is provided with a final test report of electrical safety according to standard CEI EN 60204-1 and CE declaration of conformity.**

### 2.1.8 - Technical data:

WEIGHT AND DIMENSION	
- LENGTH	2000 mm
- DEPTH	1100 mm (+100 mm)
- HEIGHT	1800 mm
- WEIGHT (APPROX.)	450 kg

SUPPLY CHARACTERISTICS	
- ELECTRICAL SUPPLY	230 V 1 phase + N + GND 50 Hz
- POWER	1,5 kW
- HYDRAULIC SUPPLY (From external network)	Tube 1/2"
- PNEUMATIC SUPPLY	6÷9 bar – 600 NL/min
- WATER DRAIN FLOW	80 L/min
- WATER TEMPERATURE (From external network)	Amb.÷60 °C

## **2.2 - BPF250-SI**

- Maximum project pressure: 350 bar.
- Static pressure (without water circulation): 1÷245 bar.
- Burst pressure (without water circulation): 1÷245 bar.
- Pulsing pressure (without water circulation): 1÷200 bar.
- Maximum temperature of external supply water: 10÷90 °C.

### ***2.2.1 - Dedicated components:***

- **Pressure intensifier (booster) with ratio 1:41 approx.** The pressure generated with 6 bar of air supply is about 245 bar. The booster is provided with a pneumatic control plant including electro-pneumatic converter, high-pressure supply valves, filtering and lubricating devices and pressure transducers with high dynamic response.
- **High-pressure test rig** made by stainless steel tube DN 10 x 1,5 mm without weld and pneumatic ball valve for high pressure.

### ***2.2.2 - Dedicated transducers:***

PRESSURE: operative range 0-500 bar.  
accuracy  $\pm 0,10\%$  of the full-scale value.  
resolution 0,01 bar, pressure probes with high dynamic response.

## **2.3 - BPF400-SI**

- Maximum project pressure: 500 bar.
- Static pressure (without water circulation): 1÷420 bar.
- Burst pressure (without water circulation): 1÷420 bar.
- Pulsing pressure (without water circulation): 1÷200 bar.
- Maximum temperature of external supply water: 10÷90 °C.

### ***2.3.1 - Dedicated components:***

- **Pressure intensifier (booster) with ratio 1:70 approx.** The pressure generated with 6 bar of air supply is about 420 bar. The booster is provided with a pneumatic control plant including electro-pneumatic converter, high-pressure supply valves, filtering and lubricating devices and pressure transducers with high dynamic response.
- **High-pressure test rig** made by stainless steel tube DN 10 x 1,5 mm without weld and pneumatic ball valve for high pressure.

### ***2.3.2 - Dedicated transducers:***

PRESSURE: operative range 0-1000 bar.  
accuracy  $\pm 0,10\%$  of the full-scale value.  
resolution 0,01 bar, pressure probes with high dynamic response.

## **2.4 - BPF600-SI**

- Maximum project pressure: 700 bar.
- Static pressure (without water circulation): 1÷600 bar.
- Burst pressure (without water circulation): 1÷600 bar.
- Pulsing pressure (without water circulation): 1÷300 bar.
- Maximum temperature of external supply water: 10÷90 °C.

### ***2.4.1 - Dedicated components:***

- **Pressure intensifier (booster) with ratio 1:100** approx. The pressure generated with 6 bar of air supply is about 600 bar. The booster is provided with a pneumatic control plant including electro-pneumatic converter, high-pressure supply valves, filtering and lubricating devices and pressure transducers with high dynamic response.
- **High-pressure test rig** made by stainless steel tube DN 10 x 1,5 mm without weld and pneumatic ball valve for high pressure.

### ***2.4.2 - Dedicated transducers:***

PRESSURE:

operative range 0-1000 bar.

accuracy  $\pm 0,10\%$  of the full-scale value.

resolution 0,01 bar, pressure probes with high dynamic

response.

### 3 - ADDITIONAL SOFTWARE

#### 3.1 - Additional software for testing

**AQ2TB-STATIC-LT** Dedicated software for ageing tests, filling with hot or cold water, pressurization by booster or pump, execution with or without water circulation and thermoregulation of the chamber temperature.

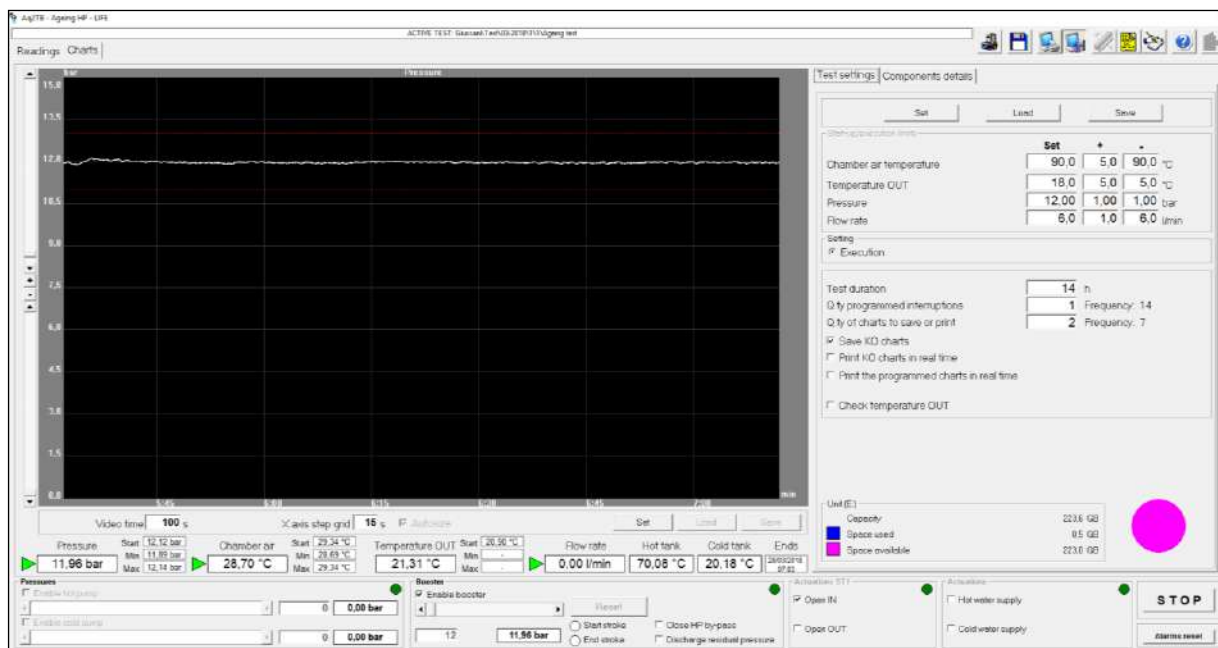

**AQ2TB-COMBI-PR** Generic software for static pressure manual tests. With this software is possible to check the leak tightness of the component under test pressurizing the plant with hydraulic multi-stages pump or pressure booster without constrains in the test sequence. It allows to perform static test according to EN, NF and ASME/CSA Standards. At the end of the acquisition, it is possible to save data and generate a multi-language report.

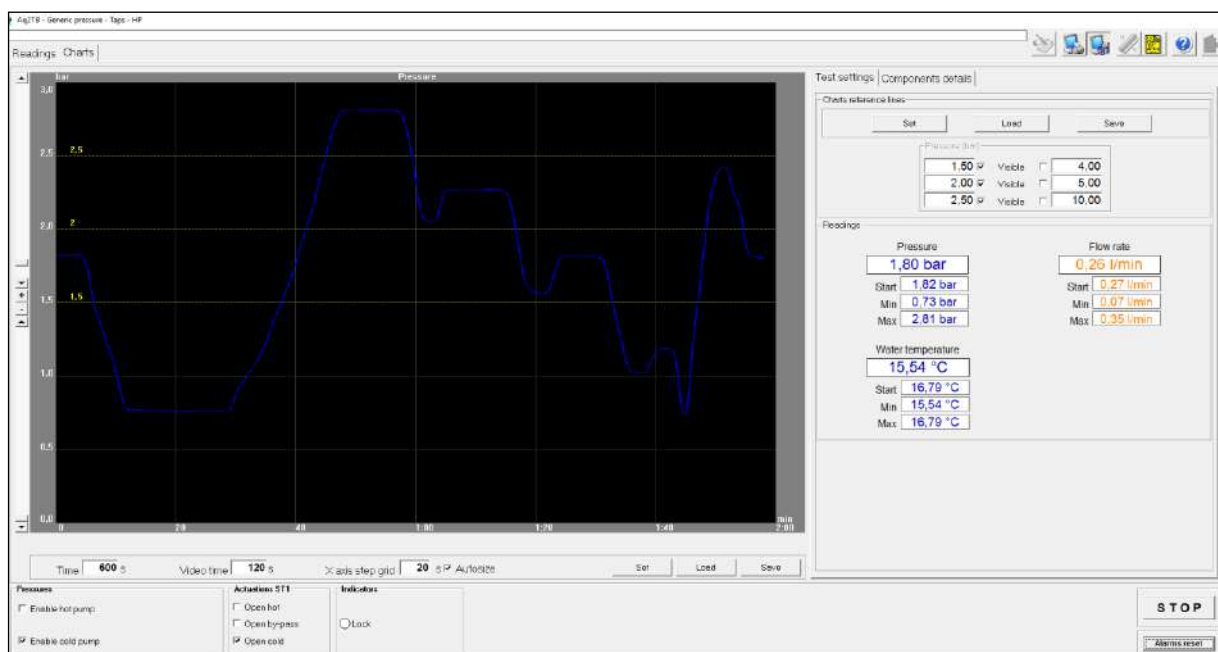

## 3.2 - Service functionalities

- AQ2TB-OPZ-MLG** Possibility to generate and print in five different languages (Italian, English, German, French and Spanish) all the test reports. The language of the report is independent from the language of the software. Each report can be generated more than one time in different languages.
- AQ2TB-DATA-EXP** Possibility to export in a TXT format file all the samples acquired during a test. It is possible to activate this function for all the software; this function is independent by the graphs shown in each software. For laboratory tests, it is possible to export the data of the entire test. For endurance tests, it is possible to export data of a single cycle, the number of saved cycle can be chosen by the operator. The maximum acquisition frequency is about 10 Hz (sample per second) for each channel.
- AQ2TB-DATA-INFO** Additional option for the personalization of the test information in all the active languages. The standard menu, composed in English by the entries “*Client*”, “*Category*”, “*Line*”, “*Model*”, “*Serial number*” and “*Test description*” can be modified in order to adapt the management of the tests on bench (including the reports) to the modality adopted by the company internally.

### 3.3 - AQ2TB-MANSYS

This optional software, installable on one or more PCs with suitable characteristics and integrated into the company network, can be used for remote management activities on the test bench.

#### Software specification:

- The software allows the remote creation, modification and cancellation of the tests execution parameters for each test. (\*)
- The software allows the access to the test data and, consequently, to their analysis and exportation; it allows the creation of the test report independently from the activity carried out on the bench in that moment. (\*\*)
- It allows the visualisation of the bench status (normal functioning or in alarm) and the kind of test in execution in real time. (\*\*)
- It allows the creation of test information registry usable on the bench during the saving procedure. (\*)

\* The bench will not have access to data in case of absence of network connection.

\*\* Features active only in case of available network connection.

#### Notes:

- In case of absence of network connection, the normal functioning of the bench is always guarantee.
- The effective functioning of the software depends on the corporate server features, and cannot be guaranteed before the start-up of the bench.

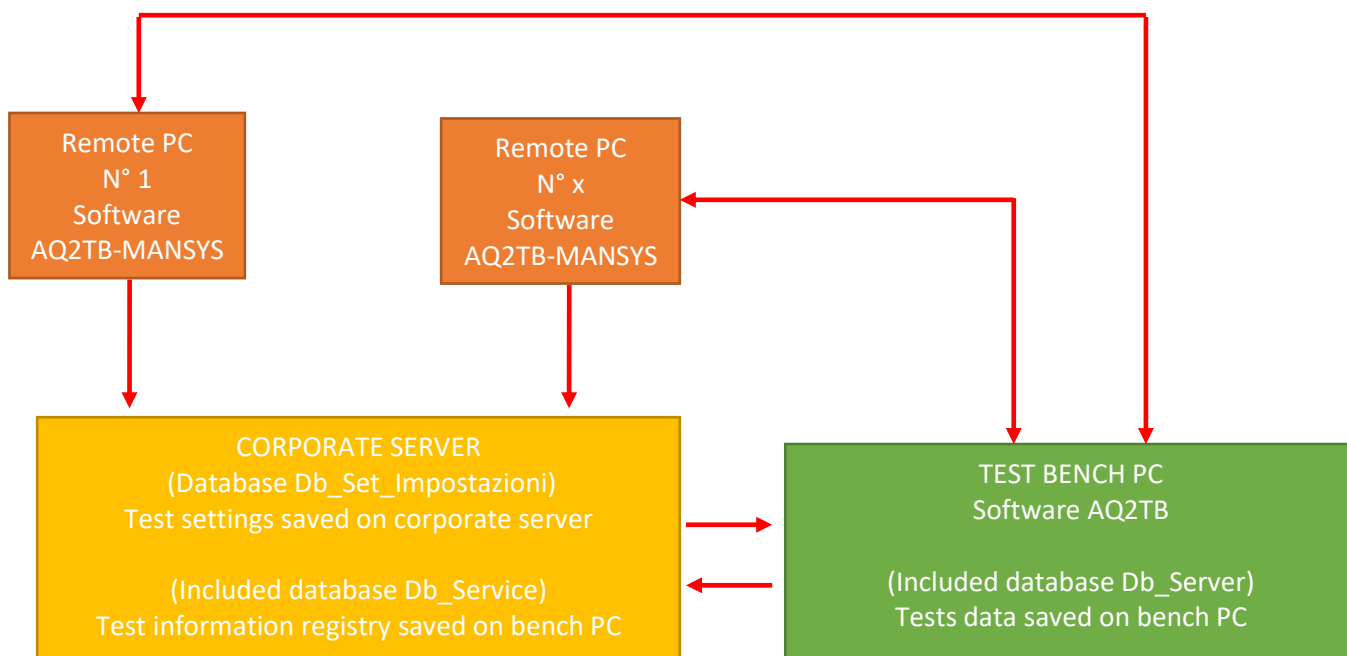

## **4 - ADDITIONAL EQUIPMENT**

### **4.1 - BPF-OPZ-C50-12**

**This option provides the installation of a multistage vertical pump** controlled by inverter and a cold water tank in order to supply continuously the component under test with stable pressure or with cyclical pressure inside the operative range of the pump.

#### **4.1.1 - Operative range:**

- Cyclical pressure with water circulation: 0,2-12,0 bar.

#### **4.1.2 - Applications:**

It allows to perform cyclical pressure tests with water circulation and to work at closed circuit.

#### **Code: P03**

#### **Cyclical pressure:**

**performed with water circulation.** Adjustable pressure from 0,2 to 12 bar and flow-rate at 50 L/min. Maximum pressure variation frequency at 0,2 Hz.

#### *Modality:*

execution of changing pressure cycles on the components under test, with adjustable flow rate. Pressure values generated by the pump, possibility to perform thermal shock if included in the configuration of the bench.

#### *Number of pieces under test:*

1-4.

#### **4.1.3 - Dedicated components:**

- **Test circuit supplied with cold or hot water** with one multistage vertical pump 2,2 kW with operative range from 0,1 to 16,5 bar, maximum flow-rate at 13,5 bar is 50 L/min (free outlet), the pump is controlled by inverter with microprocessor and feedback pressure transducer.
- **Needle valve for adjusting the flow rate during the test.**
- **Cold thermostatic tank** of about 120 litres, insulated for uses with cold water, 15/10 stainless steel structure with an overflow pipe, an outlet valve, automatic filling with control level and pneumatic filling valve. Safety level control to stop the recirculation in case of lack of water.
- **Magnetic flow meter** range 0,2÷47 L/min with pipe connection according the standards.
- **Pt100 probe Pt100** for measuring the temperature of the test chamber.

**Note:** the cost of the option includes the modifications of the software necessary for the management of additional features.



**Special versions available:**

Operative range: 0,2-6,0 bar – pressure 6,5 bar at 50 L/min (free outlet), power 1,1 kW.

Code: **BPF-OPZ-C50-6**

Operative range: 0,2-5,0 bar – pressure 5,5 bar at 100 L/min (free outlet), power 1,5 kW.

Code: **BPF-OPZ-C100-5**

Operative range: 0,2-10 bar – pressure 11,5 bar at 100 L/min (free outlet), power 3,0 kW.

Code: **BPF-OPZ-C100-10**

**4.1.4 - Dedicated transducers:**

FLOW-RATE:

accuracy  $\pm 0,25\%$  of reading value (range 10÷47 L/min)

accuracy  $\pm 0,25\%$  of reading value (range 25÷105 L/min)

resolution 0,01 L/min with precision electromagnetic

flow meter with output connected to microprocessor converter.

PRESSURE:

operative range 0-20 bar.

operative range 0-10 bar.

accuracy  $\pm 0,05\%$  of the full-scale value.

resolution 0,01 bar, probe with high dynamic response.

**4.1.5 - Dedicated software:**

**A) AQ2TB-CYCLEAUT**

Automatic endurance software for cyclical pressure tests performed with pump and with water circulation. It is possible to set the number of cycles, minimum and maximum pressure, cyclical frequency and cycle times. Control in real time of pressure and possibility to enable the thermal shock if the configuration of the bench allows that.

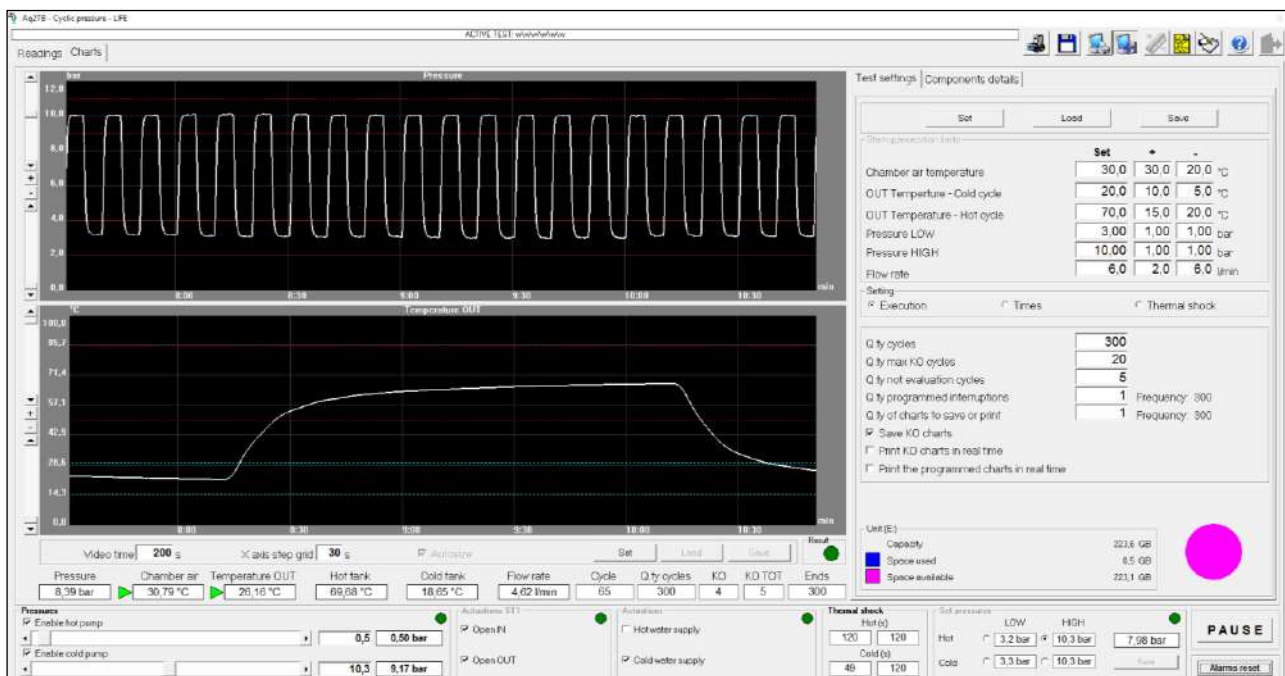

#### 4.1.6 - Technical data:

<b>WEIGHT AND DIMENSION</b>	
- LENGTH	2400 mm
- DEPTH	1100 mm (+100 mm)
- HEIGHT	1800 mm
- WEIGHT (APPROX.)	600 kg

<b>SUPPLY CHARACTERISTICS</b>	
- ELECTRICAL SUPPLY	400 V 3 phases + N + GND 50 Hz
- POWER	3,0 kW
- HYDRAULIC SUPPLY (From internal tank)	50 L/min
- PNEUMATIC SUPPLY	6÷9 bar – 600 NL/min
- WATER DRAIN FLOW	80 L/min
- WATER TEMPERATURE (From internal tank)	Amb. ÷60 °C

## **4.2 - BPF-OPZ-Q100**

**Option Q** allows to perform flow-rate tests with free outlet or with the components installed in-line for the calculation of the Kv coefficient.

**Provides for the installation of a 100 L/min multistage vertical pump** controlled by inverter.

**Note:** option Q requires the installation of the **BPF-OPZ-C** optional device.

### ***4.2.1 - Operative range:***

- Maximum flow-rate: 0,5-105 L/min.
- Minimum pressure loss at 100 L/min: approx. 0,4 bar.
- Maximum pressure at 100 L/min: approx. 10 bar.

### ***4.2.2 - Applications:***

Possibility to perform flow-rate tests with cold water at closed circuit.

**Code: F01**

**Flow-rate tests:**

with free drain performed in open circuit with cold water passage, 0,5-105 L/min range.

*Modality:*

the component under test is connected directly to the outlet or by hoses. The supply pressure can be adjusted manually or automatically with linear increase or decrease.

*Number of pieces under test:*

1.

*Example of Standard reference:*

UNI 9028 10.3.2.1 - KIWA BRL-K622/0 - EN 13618 B.1

### ***4.2.3 - Dedicated transducers:***

**FLOW-RATE:**

accuracy  $\pm 0,25\%$  of reading value (range 25÷105 L/min)

accuracy  $\pm 0,50\%$  of reading value (range 4÷25 L/min)

accuracy  $\pm 1,00\%$  of reading value (range 1÷4 L/min)

resolution 0,01 L/min with precision electromagnetic

flow meter with output connected to microprocessor converter.

#### 4.2.4 - Additional software installed:

- A) **AQ2TB-FLOW-LIN** Flow-rate test with linear increase and/or decrease of pressure and multi-trace flow-rate/pressure or pressure/flow-rate charts.

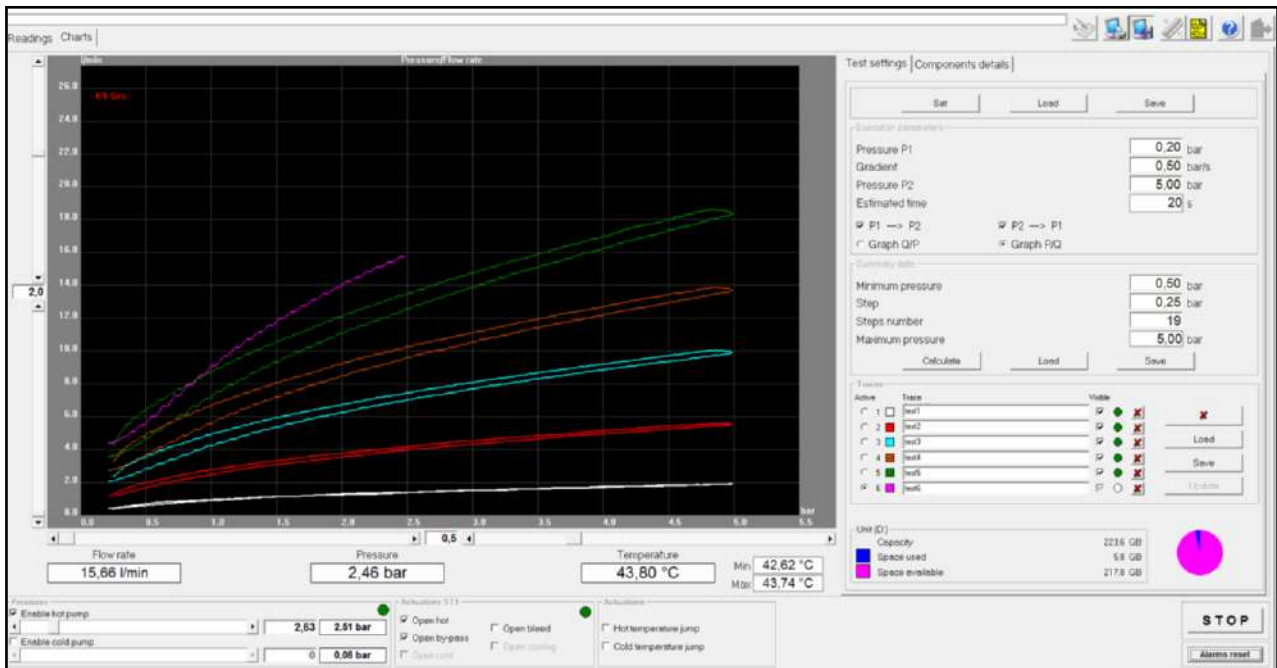

- B) **AQ2TB-FLOW-STEP** Flow-rate test with automatic pressure jumps sequence. Final report with water flow-rate, pressure and temperature.

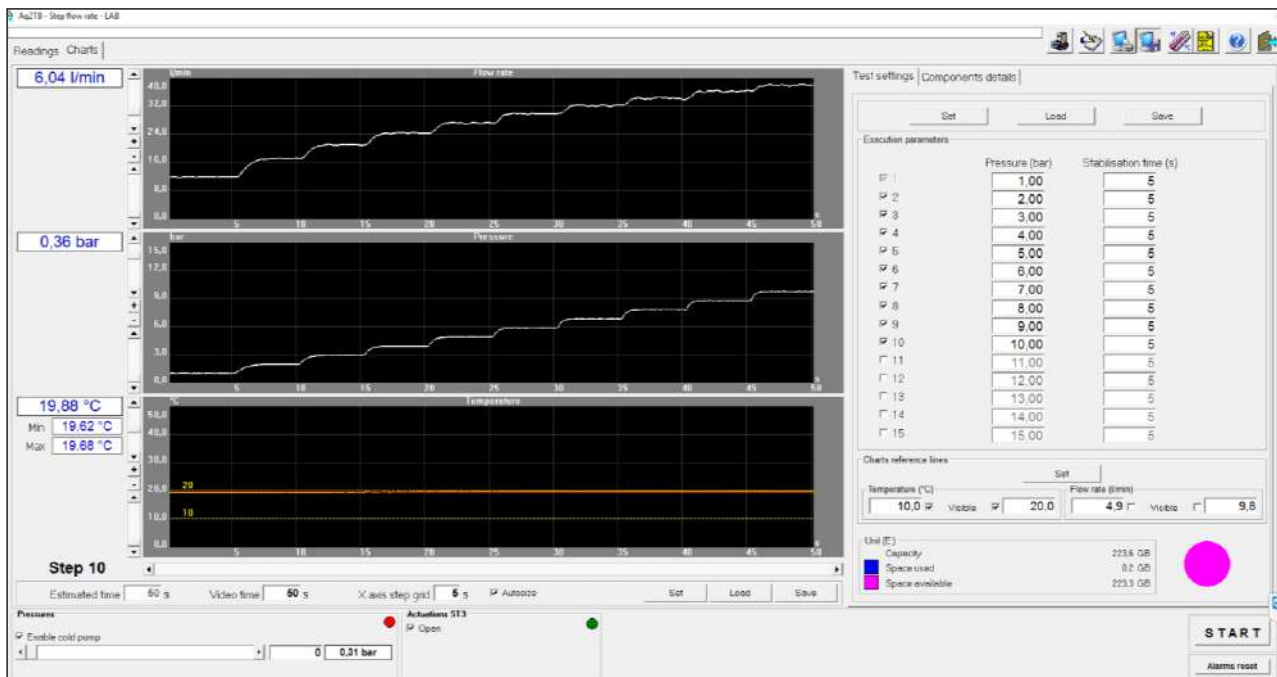

#### 4.2.5 - Dedicated components on request:

- **Low-pressure test rig according EN 1267 for performing tests with DN 15 hydraulic plant.**  
The measurement line is equipped with: shut-off valve, two pressure boxes made according the standards upstream and downstream of the test station with two precision pressure transducers.  
Code: **BPF-OPZ-KV15**.

#### 4.2.6 - Applications:

**Code: F02**

**Flow-rate tests:**

with differential pressure measurement and Kv coefficient calculation performed in open circuit with cold water passage, 0,5-100 L/min range.

*Modality:*

the inlet and the outlet of the component under test are connected to the measurement line and to the corresponding pressure transducers. The software is structured so as to perform the plant tare and the measurement of the Kv coefficient of the component, purified from the system pressure drop. The supply pressure is automatically controlled while the flow rate is manually changed by acting on a downstream adjustment valve.

*Number of pieces under tests:*

1.

#### 4.2.7 - Additional software installed on request:

**AQ2TB-KV-LAB** software for the evaluation of the pressure loss and the calculation of the Kv coefficient through the measure of the differential pressure as a function of the flow-rate. The software provide the following information as a function of the differential pressure: flow-rate (in L/min and kg/min), speed of the fluid, coefficients Kv and Cv, the flow resistance coefficient ( $\zeta$ ) and Reynolds number.

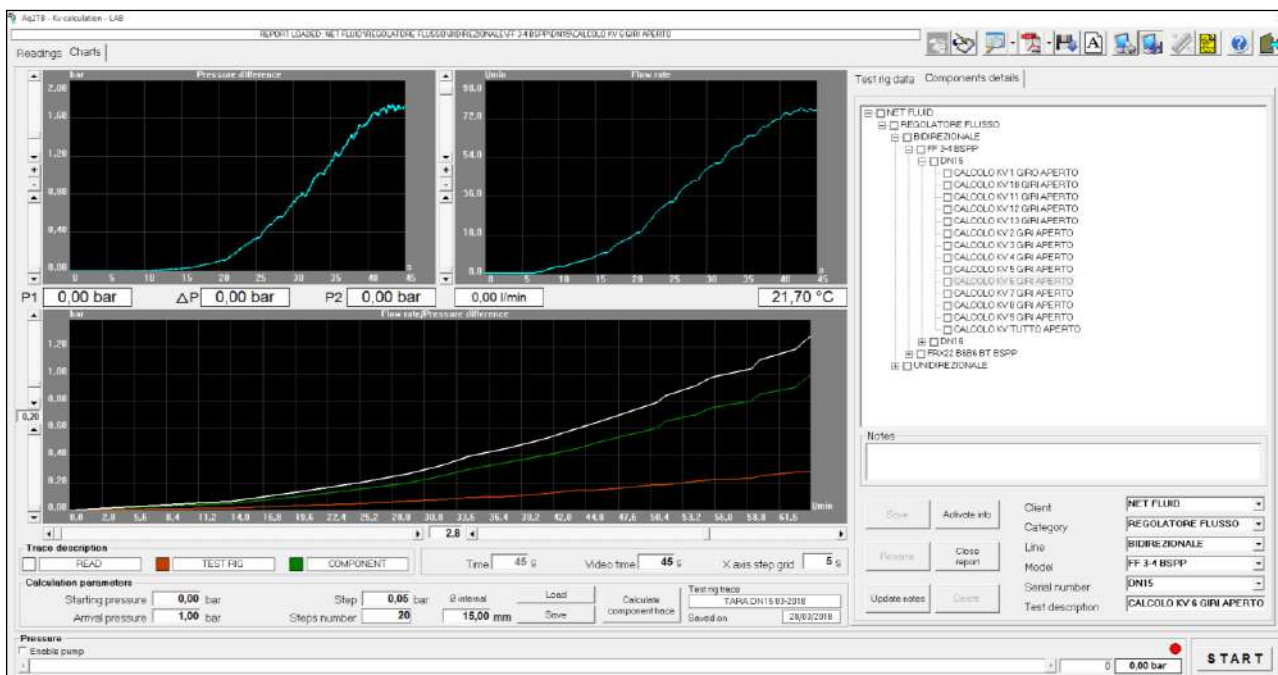

### **4.3 - BPF-OPZ-HT**

**Option HT** allows to perform test with water temperature up to 93 °C generated by a dedicated tank with integrated heating system.

**Note:** option HT requires the installation of the **BPF-OPZ-C** optional device.

#### ***4.3.1 - Operative range:***

- Maximum water temperature: 93±2 °C.
- Stability: ±0,5 °C.

#### ***4.3.2 - Applications:***

- All the pressure tests can be performed by filling the component with hot water (**test code: PT01H, PT02H, PT03H and PT04H**).
- The tests made with pump and water circulation with open circuit, can be performed with controlled temperature hot water.

#### ***4.3.3 - Dedicated components:***

- **Hot thermostatic tank** of about 120 litres, insulated for uses up to 93 °C, stability ±0,5 °C, 15/10 stainless steel structure with an overflow pipe, an outlet valve, vertical stirrer, automatic filling with control level and pneumatic filling valve. Safety level control to stop the heating group and the pump in case of lack of water. Heating group equipped with resistances coated incoloil made (maximum power: 7,5 kW). Temperature control by PC. Fibreglass covering insulating surface.

**KIT-FILTROBWT** water treatment to reduce the hardness and contamination of water supply, including mechanical filter and flow counter.

Weight: 6,0 kg – Filtering capacity: 8100 L at 17 °f (10 °d).

**Note:** the cost of the option includes the modifications of the software necessary for the management of additional features.

#### 4.3.4 - Technical data:

<b>WEIGHT AND DIMENSION</b>	
- LENGTH	2700 mm
- DEPTH	1200 mm (+100 mm)
- HEIGHT	1900 mm
- WEIGHT (APPROX.)	700 kg
<b>SUPPLY CHARACTERISTICS</b>	
- ELECTRICAL SUPPLY	400 V 3 phases + N + GND 50 Hz
- POWER	13 kW
- HYDRAULIC SUPPLY (From internal tanks)	100 L/min
- PNEUMATIC SUPPLY	6÷9 bar – 600 NL/min
- WATER DRAIN FLOW	80 L/min
- WATER TEMPERATURE (From internal tanks)	Amb. ÷ 93 °C

## **4.4 - BPF-OPZ-HC**

### **Test chamber's air temperature adjustable from ambient to 110 °C.**

Option HC provides for the heating of the test chamber through a mechanical ventilation. This solution is necessary for all the tests that require the component is kept warm but without water circulation.

#### **4.4.1 - Operative range:**

- Maximum air temperature: 110 °C.
- Stability:  $\pm 0,5$  °C.

#### **4.4.2 - Dedicated components:**

- **Insulated test chamber, size 1650 x 550 x depth 400-600 mm** with free gap between the collectors adjustable from 250 to 1400 mm, aluminium profile folding safety door. Aluminium profile guides for test collectors that are fitted on sliding tracks and can be horizontally translated. Forced circulation test chamber heating with finned resistors placed at the back. Heating power about 3 kW. Forced air circulation with axial fan.

#### **4.4.3 - Technical data:**

<b>WEIGHT AND DIMENSION</b>	
- LENGTH	3000 mm
- DEPTH	1200 mm (+100 mm)
- HEIGHT	1900 mm
- WEIGHT (APPROX.)	800 kg
<b>SUPPLY CHARACTERISTICS</b>	
- ELECTRICAL SUPPLY	400 V 3 phases + N + GND 50 Hz
- POWER	16 kW
- HYDRAULIC SUPPLY (From internal tanks)	100 L/min
- PNEUMATIC SUPPLY	6÷9 bar – 600 NL/min
- WATER DRAIN FLOW	80 L/min
- WATER TEMPERATURE (From internal tanks)	Amb.÷93 °C

**Note:** the cost of the option includes the modifications of the software necessary for the management of additional features.



## **4.5 - BPF-OPZ-TC**

**Option TC** allows the performing of thermal cycle tests on several components by alternate circulation of cold water and hot water.

**Note:** option TC requires the installation of the **BPF-OPZ-HT** optional device.

**Note:** option TC requires the installation of an external cooling system for the cold water tank.

### ***4.5.1 - Operative range:***

- Cold water tank temperature:  $20 \pm 5$  °C.
- Hot water tank temperature:  $93 \pm 2$  °C.
- Stability:  $\pm 0,5$  °C.

### ***4.5.2 - Applications:***

**Code:** TC01

**Thermal cycle:**

test carried out in open circuit by alternating the supply with cold and hot water.

*Modality:*

thermal cycle performed with cold and hot water from internal tanks, supply from inverter-controlled pumps and pressure adjustable from 0,5 to 10,0 bar.

Minimum cycle time: 5 minutes cold + 5 minutes hot.

The hot tank temperature is controlled by an electronic regulator and 3 heating resistances. The cold tank temperature is controlled by an external chiller.

*Number of pieces under test:*

1-4.

*Example of Standard reference:*

DVGW W543 5.5.9 - EN 12293 - EN 13618 B.7

### ***4.5.3 - Dedicated components:***

- **Test rig** with two multistage vertical pumps with operative range from 0,2 to 10,0 bar. Maximum flow rate 100 L/min, power 3 kW, the pumps are controlled with an inverter by feedback pressure transducer.
- **Two magnetic flow meters** range  $0,2 \div 105$  L/min with pipe connection according the standards.

**Note:** the cost of the option includes the modifications of the software necessary for the management of additional features.

#### 4.5.4 - Additional software installed:

A) **AQ2TB-1LD-H&C** this software allows to perform thermal shock tests on showers, flexible hoses and generic devices alternating cold and hot water supply.

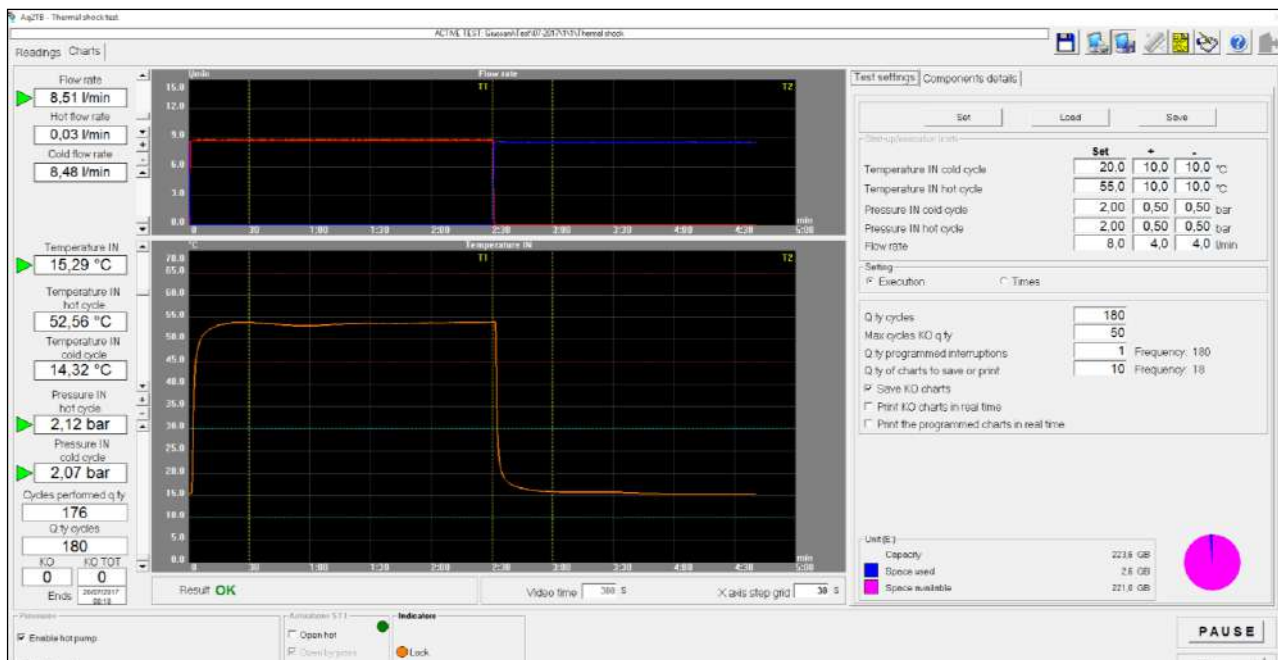

#### 4.5.5 - Technical data:

WEIGHT AND DIMENSION	
- LENGTH	3000 mm
- DEPTH	1300 mm (+100 mm)
- HEIGHT	1900 mm
- WEIGHT (APPROX.)	900 kg
SUPPLY CHARACTERISTICS	
- ELECTRICAL SUPPLY	400 V 3 phases + N + GND 50 Hz
- POWER	18 kW
- HYDRAULIC SUPPLY (From internal tanks)	100 L/min
- PNEUMATIC SUPPLY	6÷9 bar – 600 NL/min
- WATER DRAIN FLOW	80 L/min
- WATER TEMPERATURE (From internal tanks)	Amb.÷93 °C

## **5 - OPTIONAL DEVICES**

### **5.1 - BPF-OPZ-PM**

**It provides the installation of a manual screw pump** to perform the initial starting pressurisation with a value higher than that of the mains supply or of the vertical pump, if installed.

**The pressure can be adjusted up to 100 bar by acting on the hand wheel located in an accessible area.**

### **5.2 - BPF-OPZ-VAC**

The vacuum option allows to correctly fill components (radiators, exchangers, cast bodies, etc.) with water which, for their particular internal configuration, are difficult to fill completely with water.

The air present in the component is completely vacuumed to quickly and completely fill with test water, thus avoiding possible explosions if air is trapped inside the component during burst tests.

#### **5.2.1 - Dedicated components:**

- **8 m<sup>3</sup>/h vacuum pump** with vacuum trap, vacuum break valve, vacuum supply line with servo-driven shut-off ball valves.
- **Shut-off valves.**
- **Vacuum transducer** connected to the computer.

#### **5.2.2 - Burst test sequence with OPZ-VAC:**

- ◇ Piece installation on test station.
- ◇ Door closure.

#### **Filling sequence:**

- ◇ Pump ignition, component and test rig emptying.
- ◇ Final vacuum check.
- ◇ Vacuum line closure, pump switch-off and seal check.
- ◇ Drain safety trap valve opening.

#### **Pressurisation sequence:**

- ◇ Water supply from external network and waiting for complete filling.
- ◇ Pressure rises with the set gradient.
- ◇ Stabilisation at test pressure.
- ◇ Optional: pressure line closure and component loss valuation within the set tolerance.
- ◇ Re-opening of the supply line at the end of the stabilisation time.
- ◇ Pressure rises up to burst with positive gradient or drop to zero with negative gradient.

**Note:** the VAC option includes changes to the software necessary to integrate the emptying sequence of the tested component.

**Note:** the VAC option requires the installation of a flow-meter.

## **5.3 - CHILLER OPTION**

### ***5.3.1 - Applications:***

External chiller used to keep constant the temperature of the cold water tank.

The chiller is connected to the cold water tank to maintain the constant temperature on summer or anytime there is a passage of water from hot to cold tank.

### ***5.3.2 - Technical data:***

Several model are available, the most common is **TAL A0**

- Cooling power: 10,9 kW.
- Water temperature range: 10-25 °C.
- Electrical power: 4,6 kW.
- Dimension: 740 x 600 x (h) 1300 mm.
- Weight: ~180 kg.

**Code: TALA0PMSBCX0000**

## **5.4 - BPF-OPZ-DELTA-L**

Measuring device of the elongation of the pipes under static pressure.

The device can be installed on the static pressure outlet collector in the versions equipped with a sliding carriage.

The measurement is made on a graduated ruler that can be positioned in line with the mobile carriage.

## **5.5 - BPF-OPZ-EXT-OUT**

Test rig for static pressure and pulsing pressure test with rear outlets intercepted by servo-driven ball valves in order to perform static pressure tests and pulsing pressure tests on external devices, such as climatic chambers, handling systems, etc.

The position of the outlets and the connection to the external devices must be defined with the user according to the position of the external devices.

## **5.6 - SPARE PARTS KIT**

The spare parts kit includes transducers, valves, fuses, lamps according to the configuration of the test bench.

**Code: SPARE-PARTS**

### **Note:**

Basic kit including check valve, fuses and lamps provided with the test bench.

(Code: **SPARE-PARTSBASIC-F**)

## **5.7 - FITTINGS KIT**

Kit of fittings including reductions, nipples, caps, gaskets and screws according the configuration of the test bench. **Code: SERV.KIT-BPF.PN250**

**Note:** includes kit of hand tools comprising adjustable wrench, screwdrivers, hex key and hydraulic key. **Code: 2FRGKIT.UT**

## **6 - PACKAGING**

### **6.1 - BPF packaging (length 2000 mm)**

Wooden box with anti-vibrating damper.

Exp. model with sealed plastic bag and ISPM treatment.

Code: 8CASSABPF200EXP

### **6.2 - BPF packaging (length 2300 mm)**

Wooden box with anti-vibrating damper.

Exp. model with sealed plastic bag and ISPM treatment.

Code: 8CASSABPF230EXP

### **6.3 - BPF packaging (length 2400 mm)**

Wooden box with anti-vibrating damper.

Exp. model with sealed plastic bag and ISPM treatment.

Code: 8CASSABPF240EXP

### **6.4 - BPF packaging (length 2700 mm)**

Wooden box with anti-vibrating damper.

Exp. model with sealed plastic bag and ISPM treatment.

Code: 8CASSABPF270EXP

### **6.5 - BPF packaging (length 3000 mm)**

Wooden box with anti-vibrating damper.

Exp. model with sealed plastic bag and ISPM treatment.

Code: 8CASSABPF300EXP

### **6.6 - BPF packaging (length 3000 mm - TC)**

Wooden box with anti-vibrating damper.

Exp. model with sealed plastic bag and ISPM treatment.

Code: 8CASSABPF3TCEXP

### **6.7 - Accessories packaging**

Wooden box with anti-vibrating damper.

Exp. model with sealed plastic bag and ISPM treatment.

Code: 8CASSA-WORKT

Code: 8CASSATALA0-EXP

## 7 - EXAMPLES

### VERSION - 2000 mm

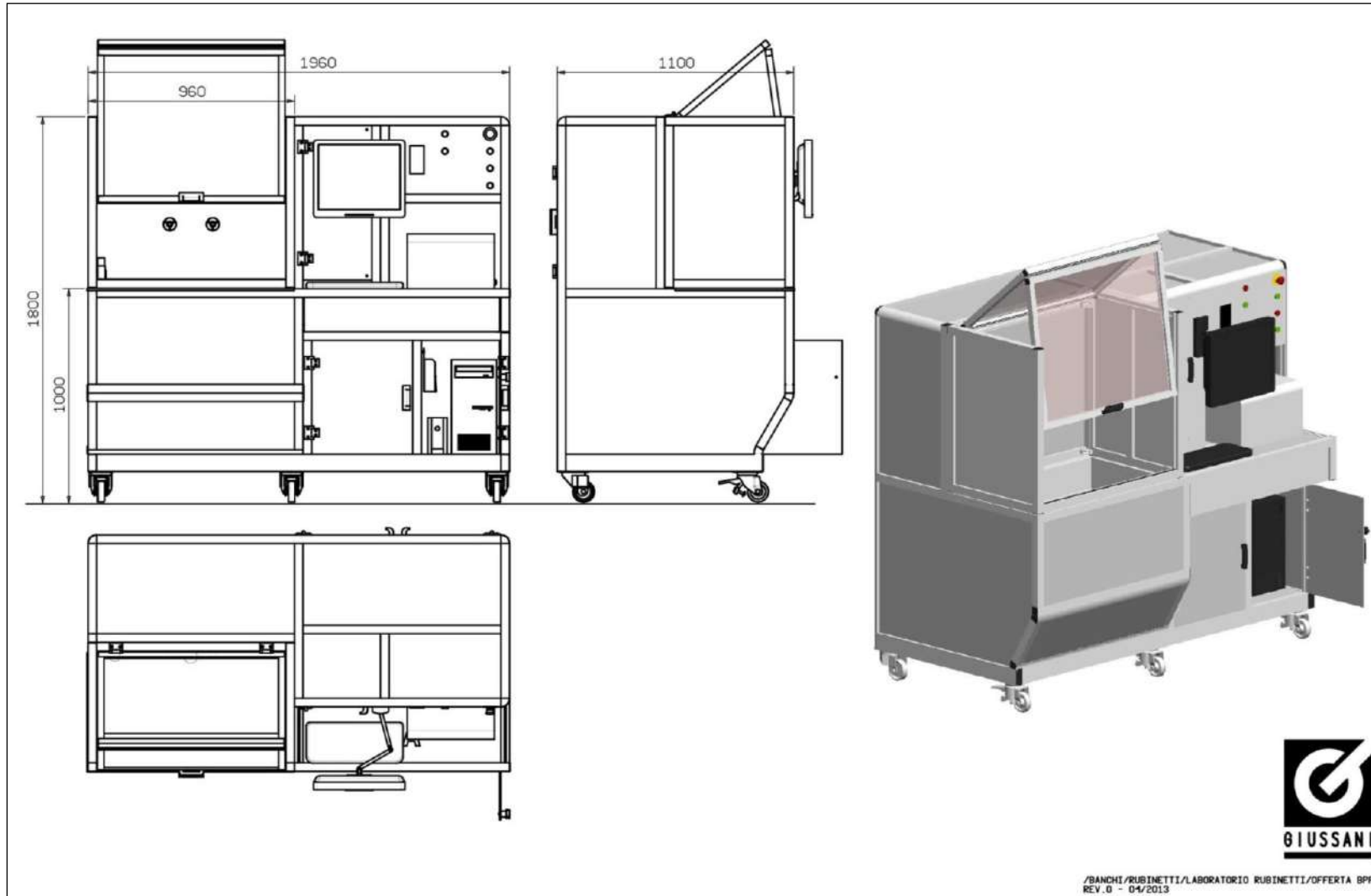

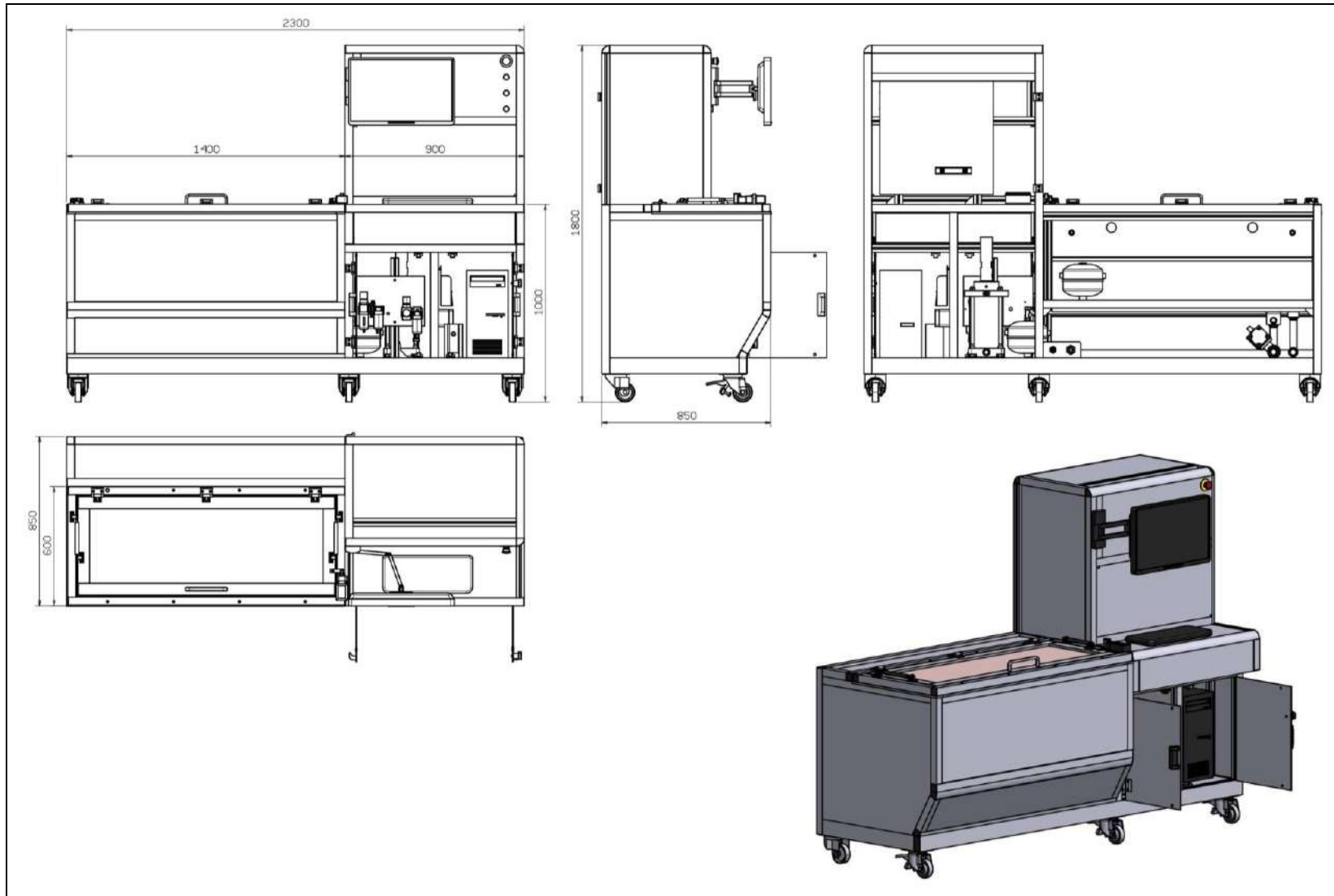

## VERSION - 2400 mm

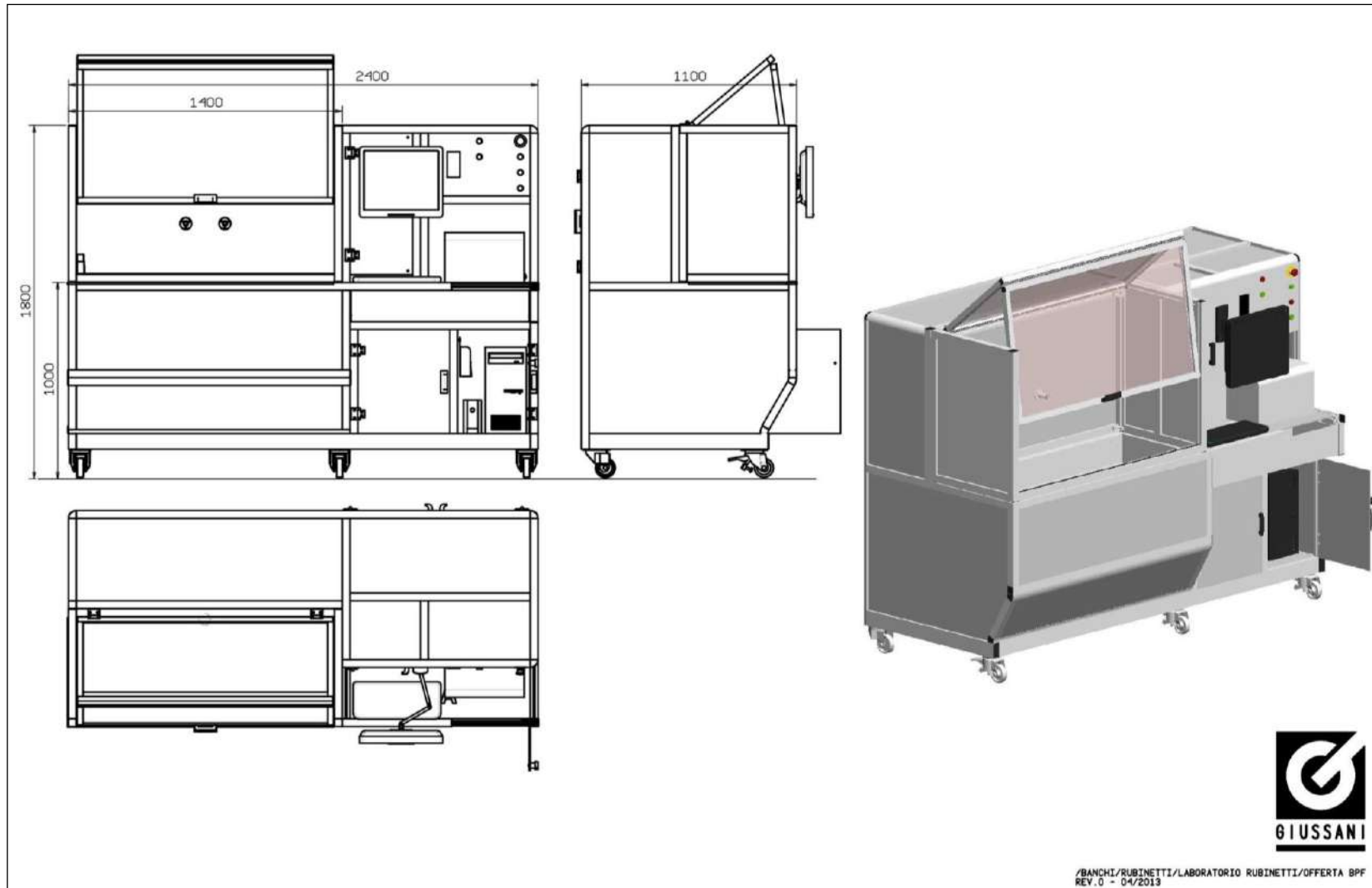



### VERSION - 2700 mm

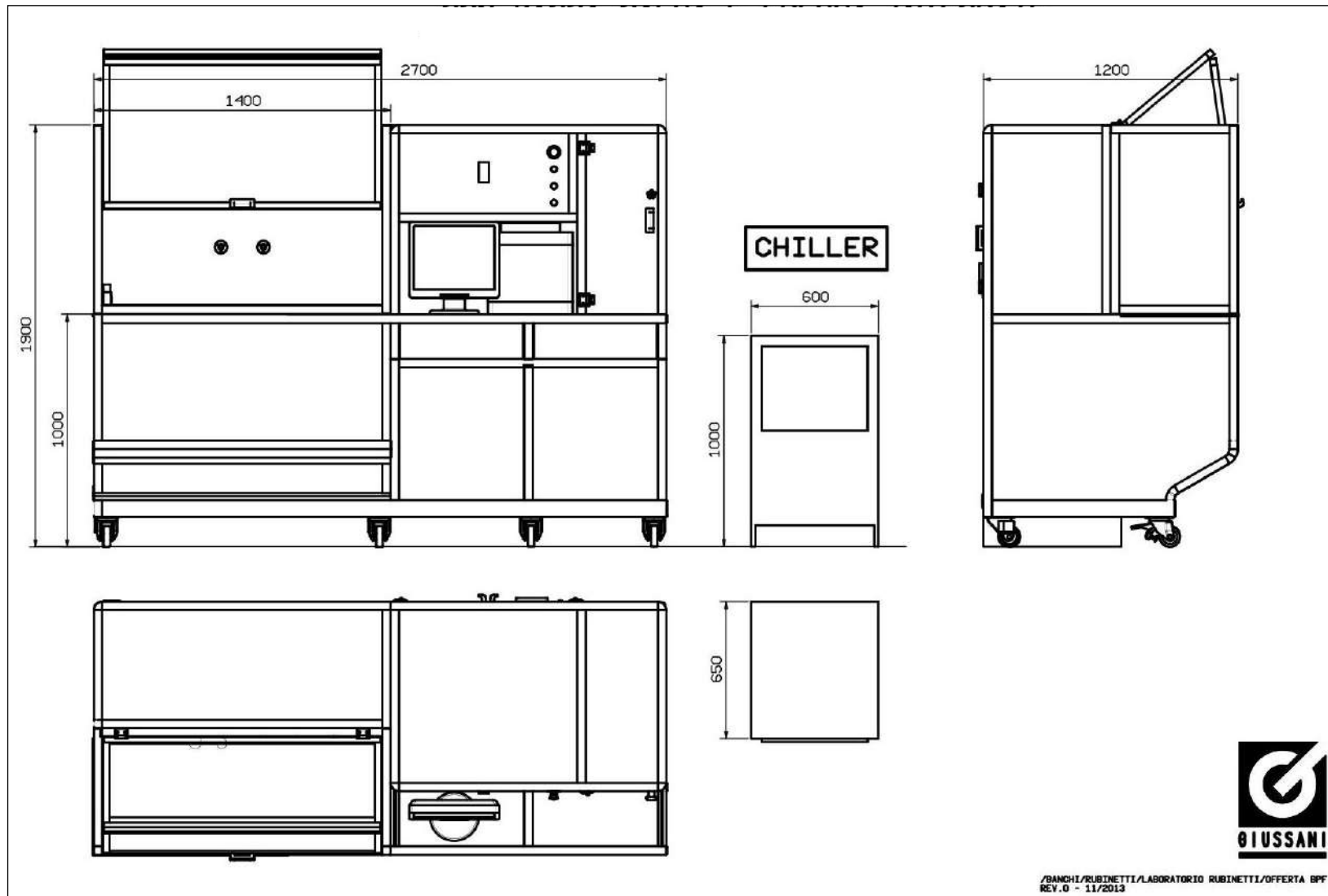

### VERSION - 3000 mm



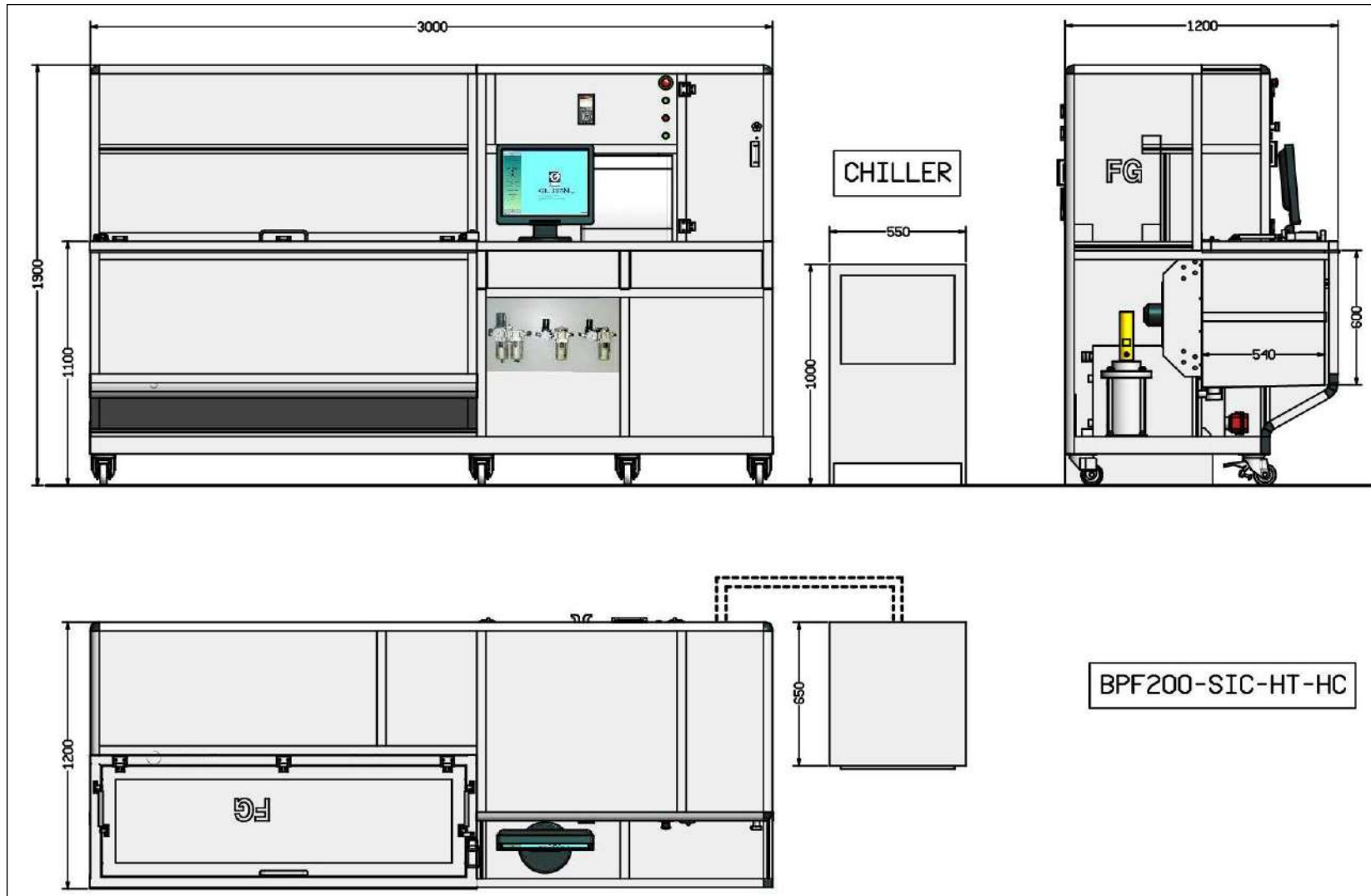

**VERSION WITH VERTICAL CHAMBER**

